

S3.1

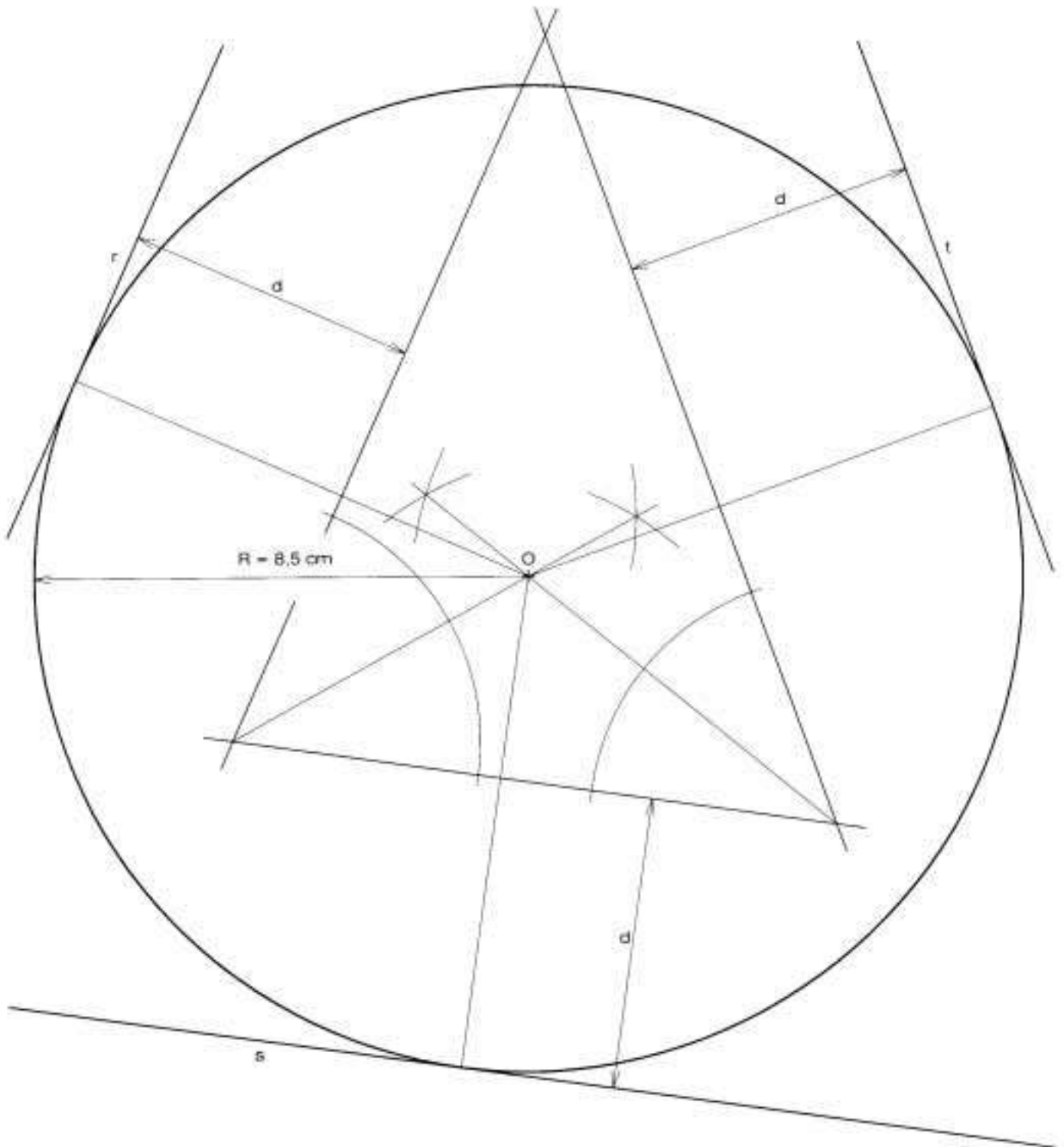

83,2

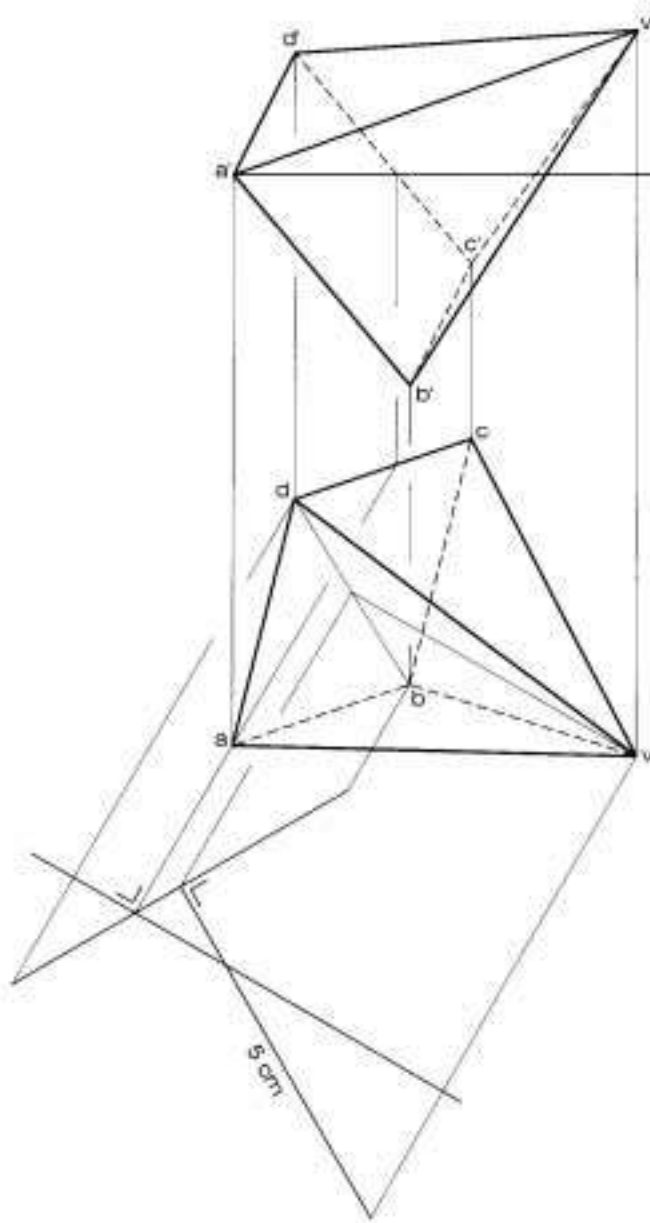

S3.3A

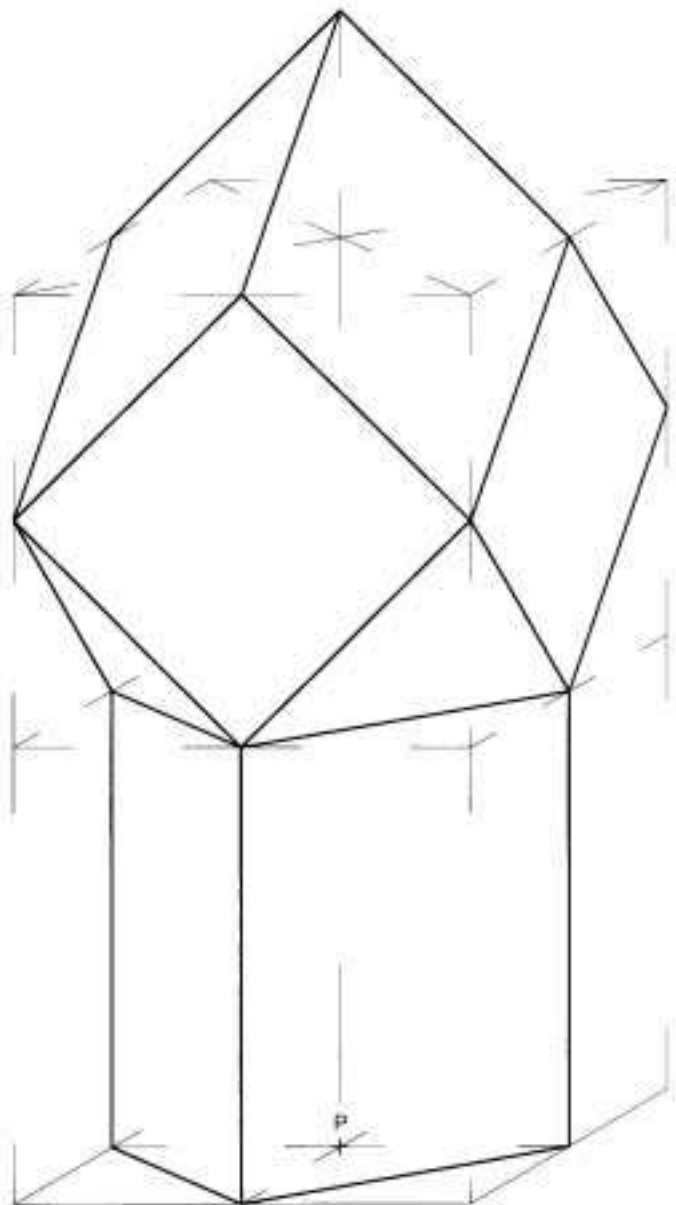
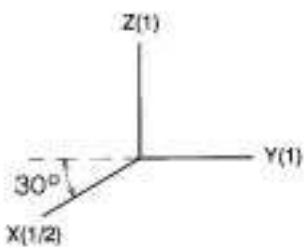
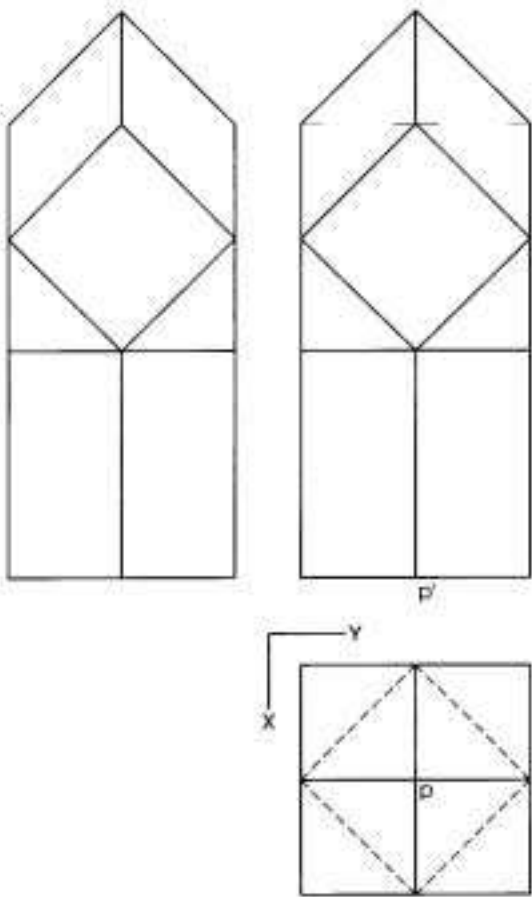

S3.3B

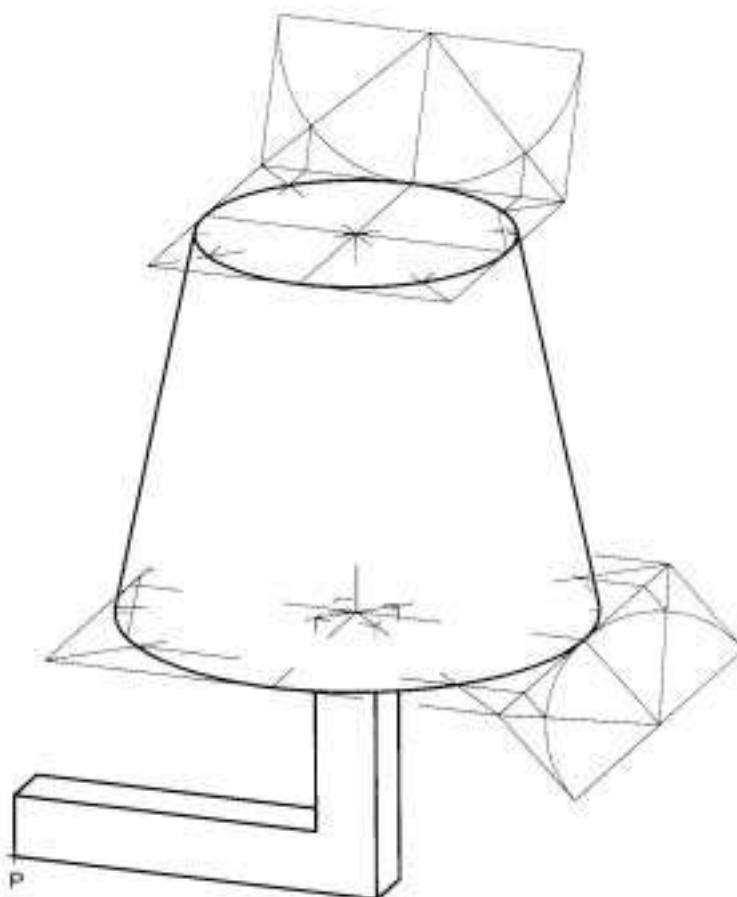
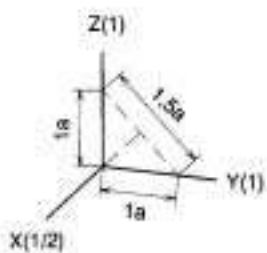
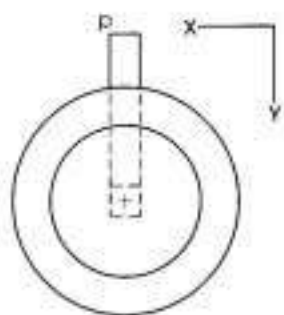
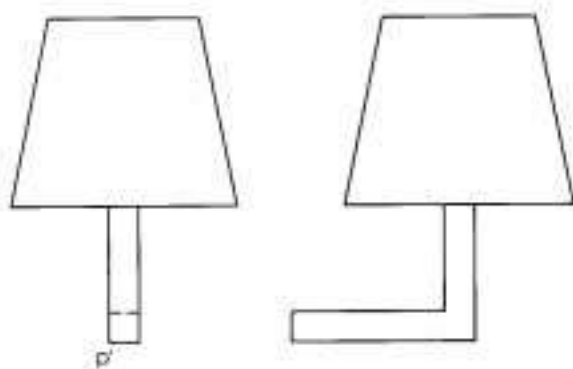

SÈRIE 2

S2.1

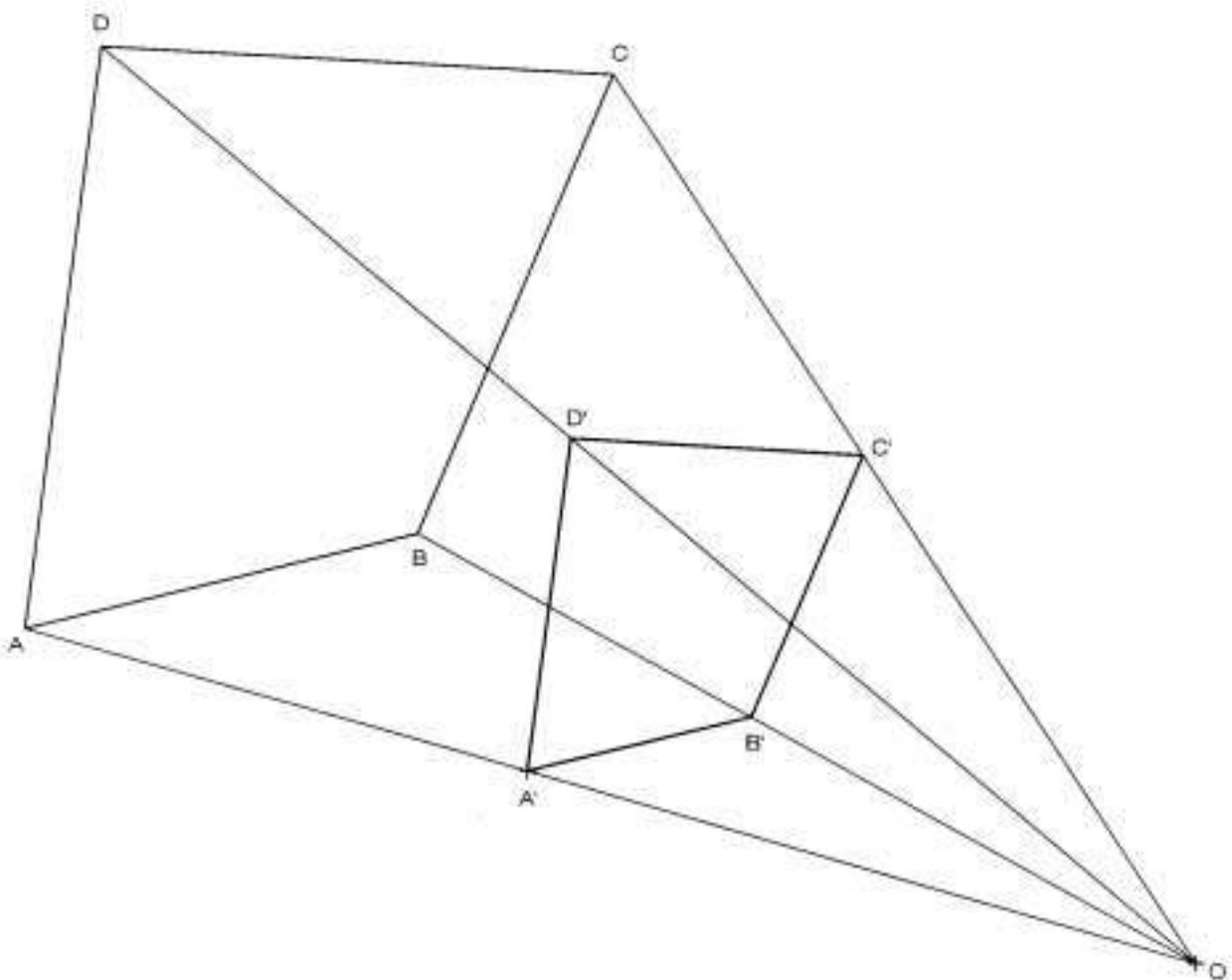

S2.2

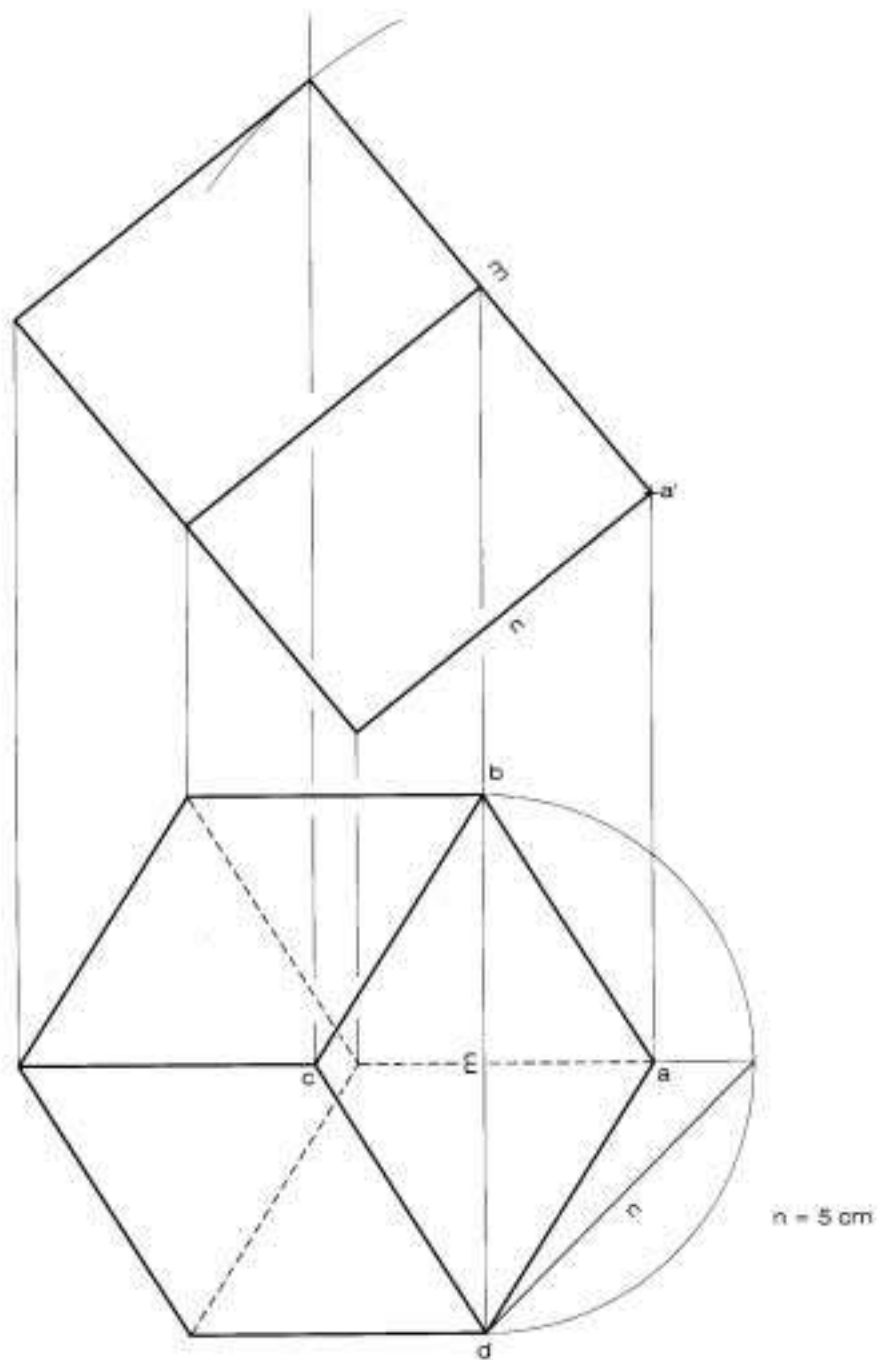

S2.3A

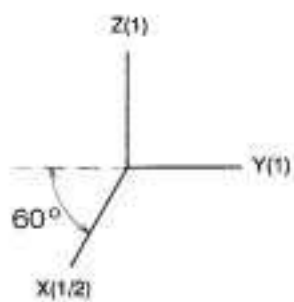
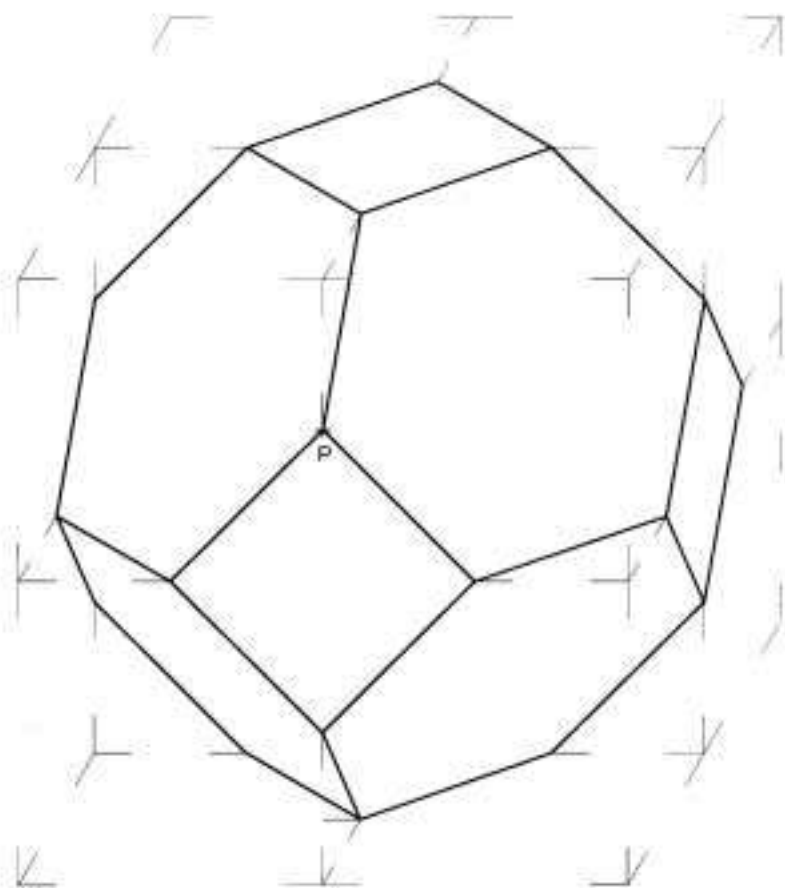
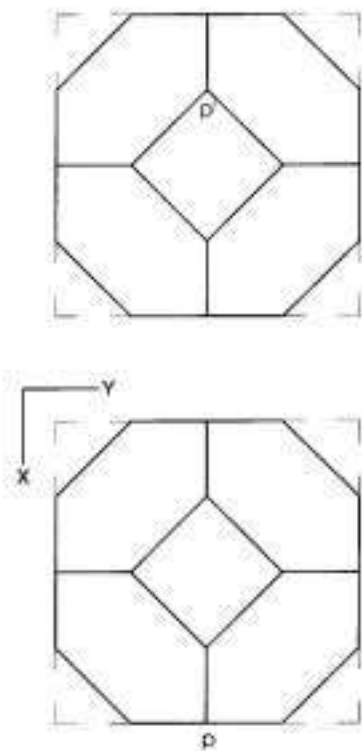

S2.3B

