

SÈRIE 3

Exercici 1

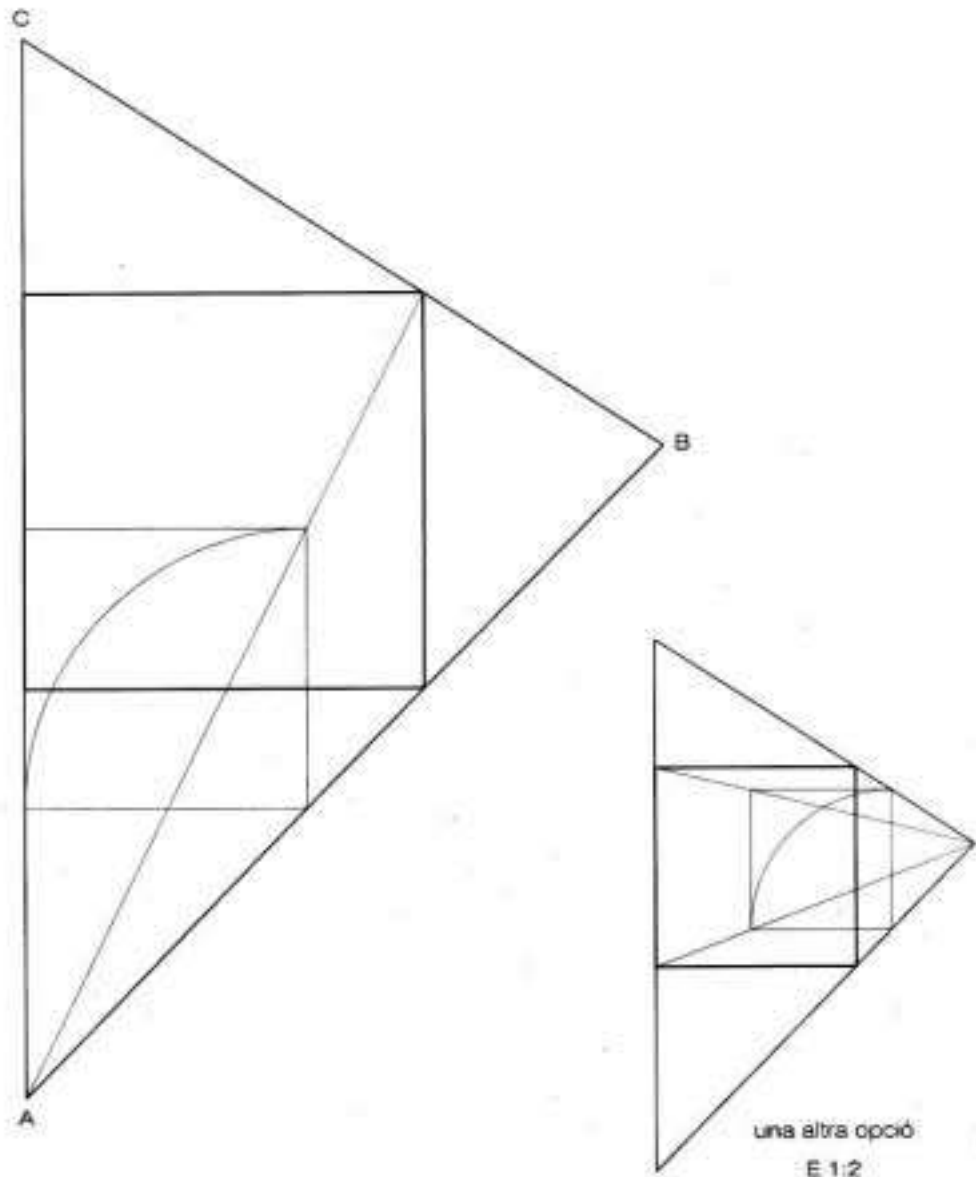

### Exercici 2 Opció A

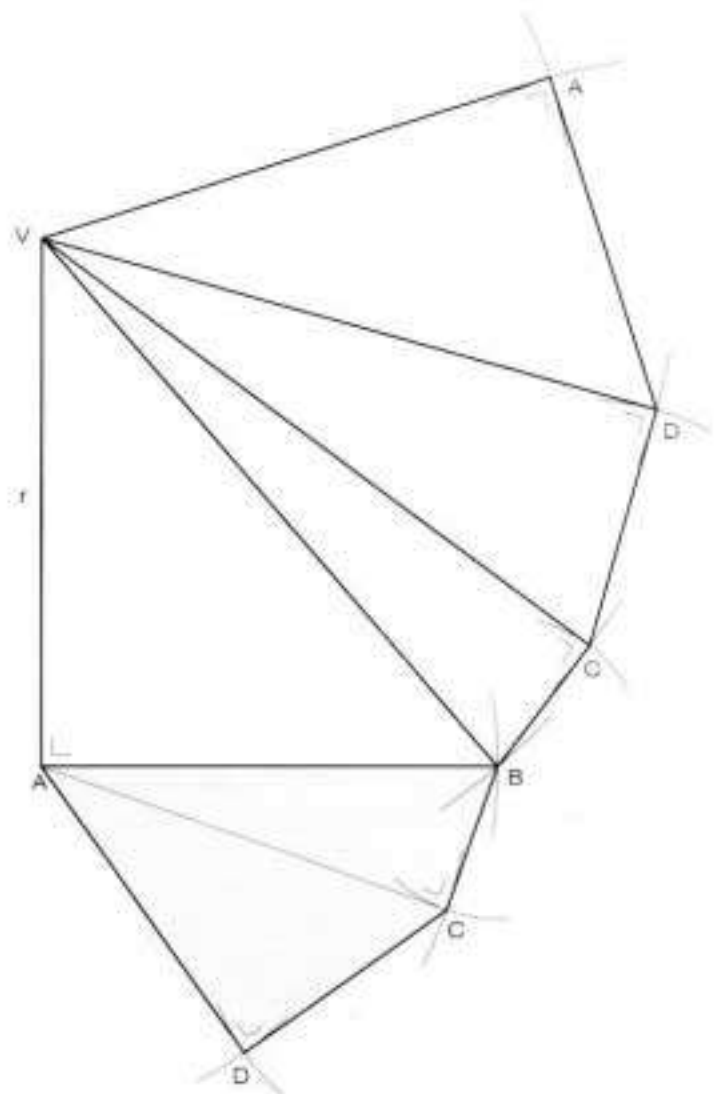
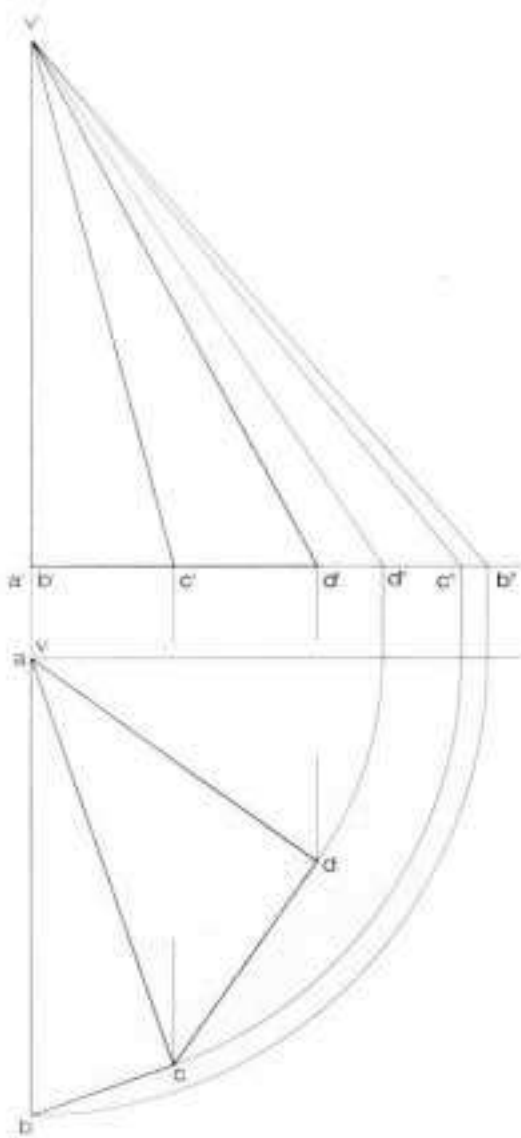

totes quatre cares són triangles rectangles

### Exercici 2 Opció B

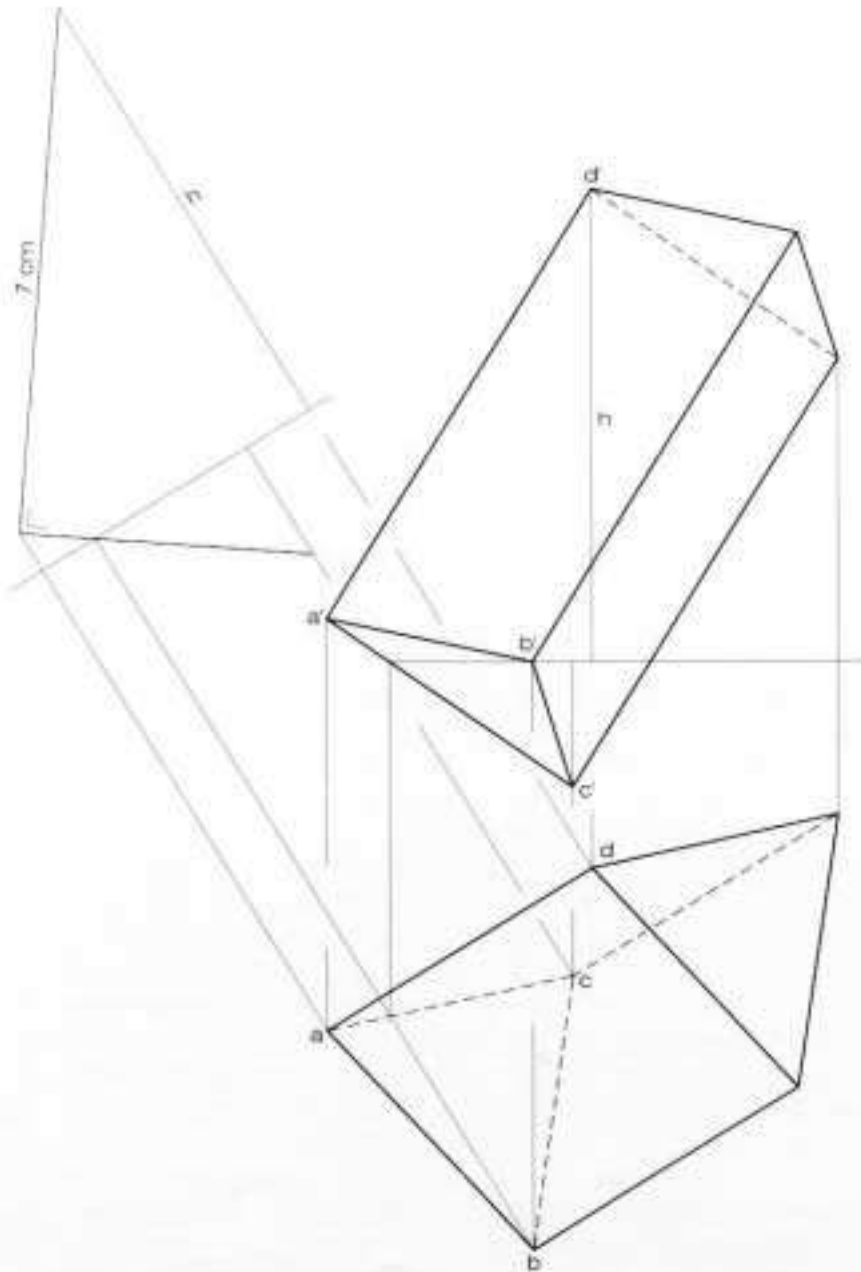

### Exercici 3 Opció A

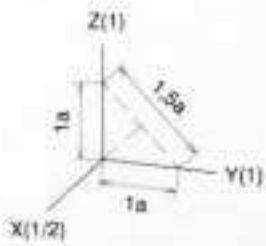
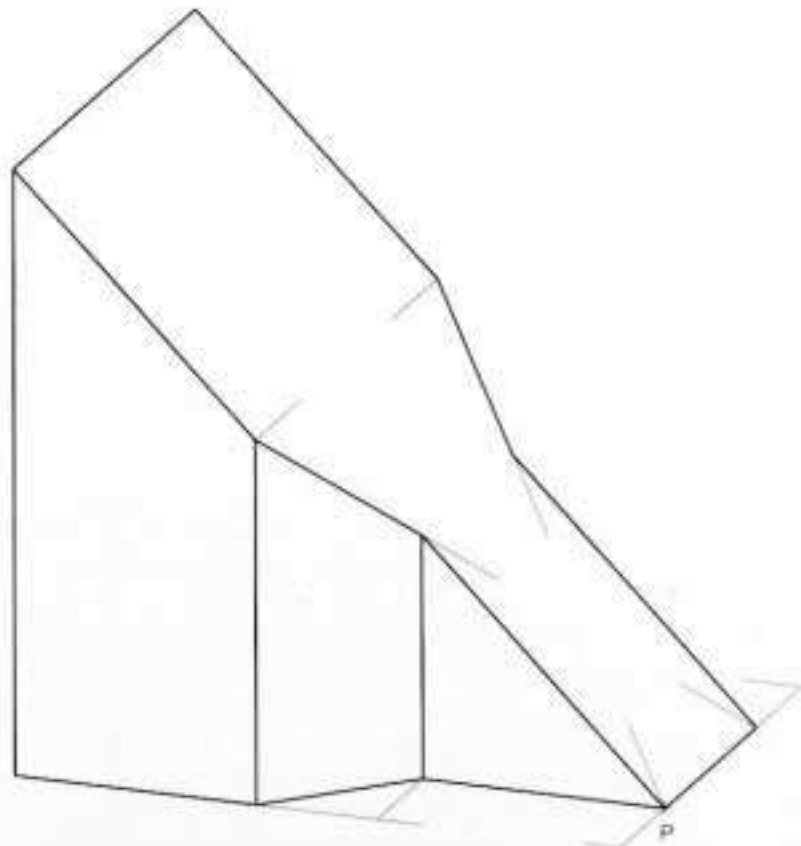
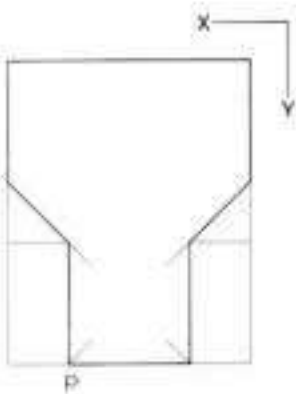
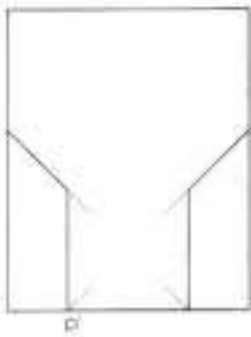





## Exercici 2 Opció A

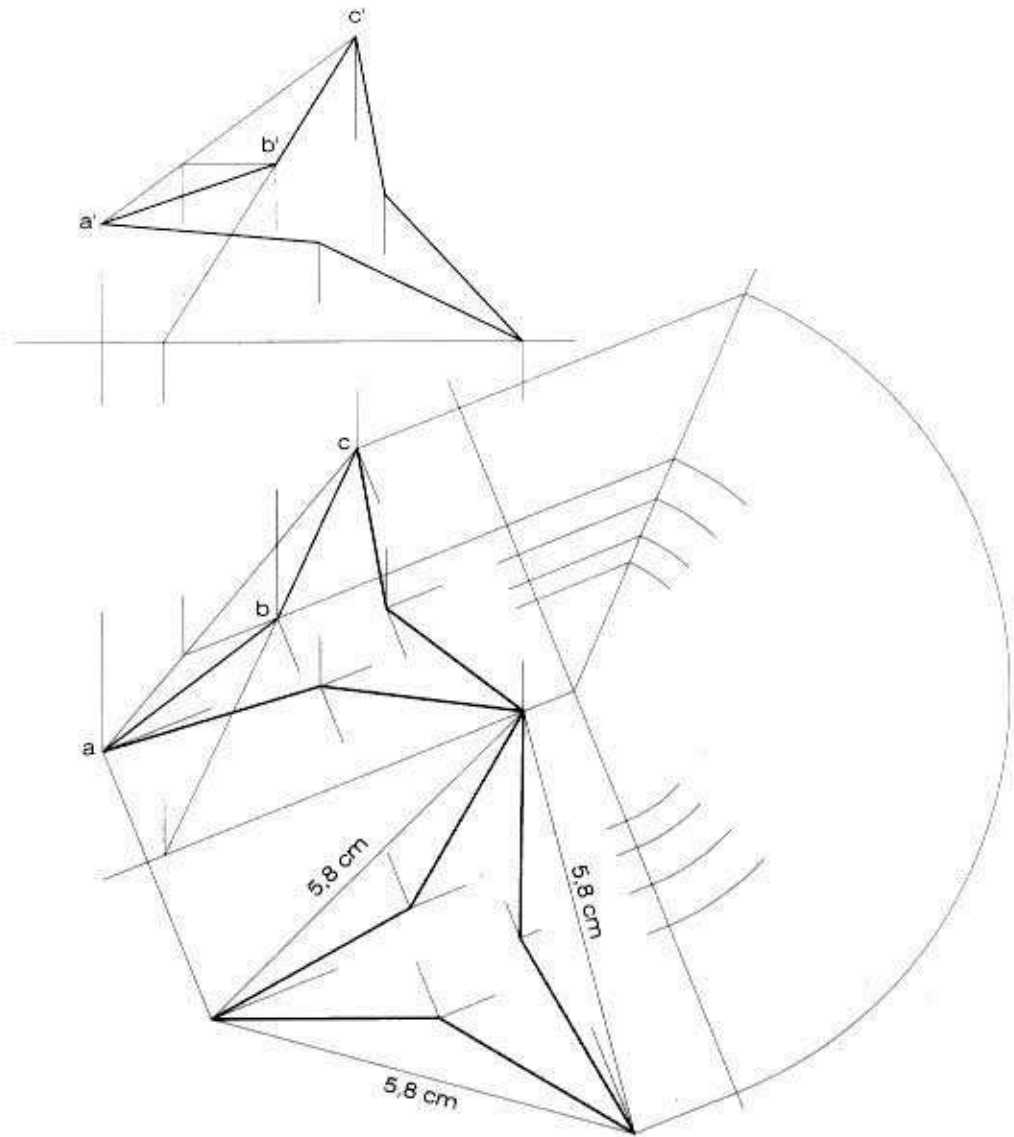





### Exercici 3 Opció A

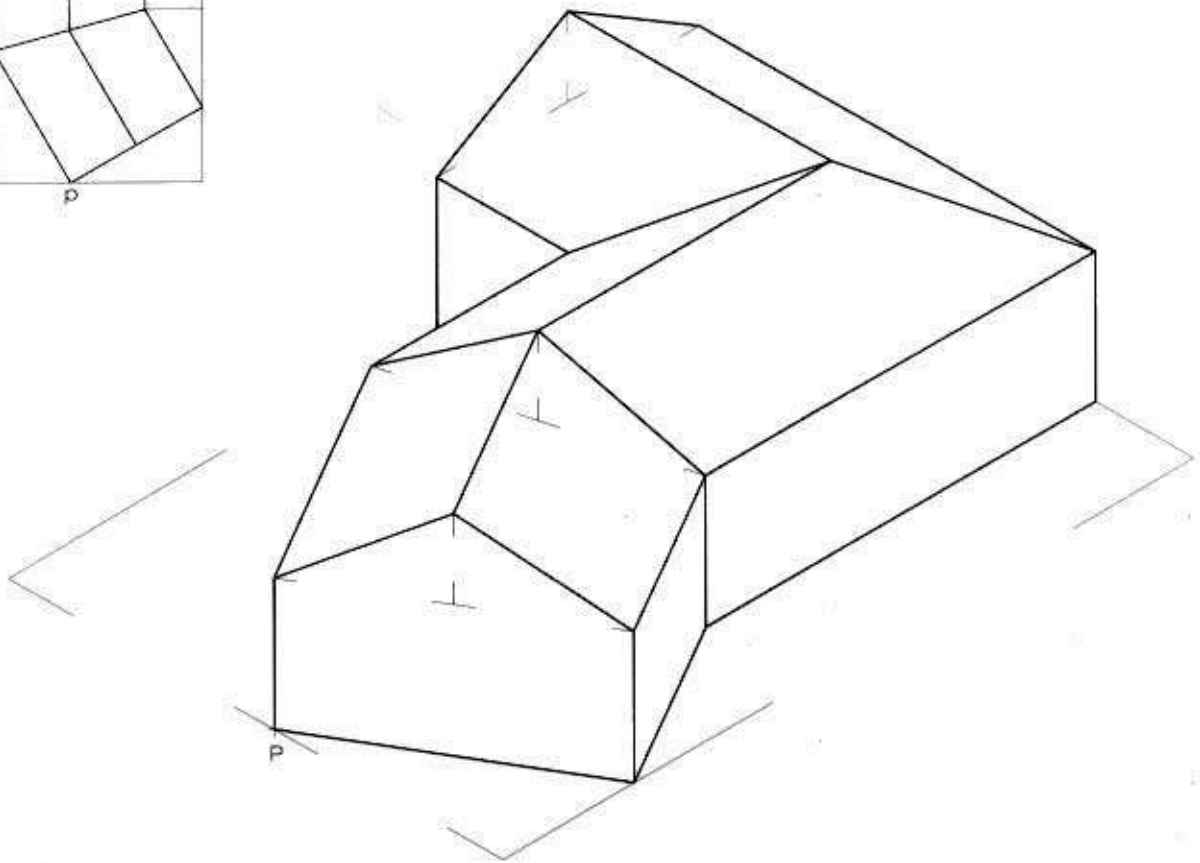
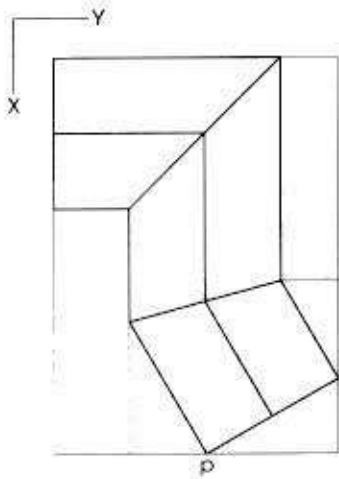
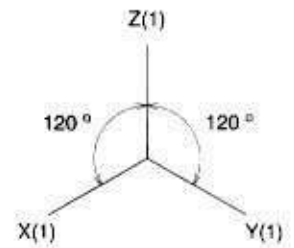
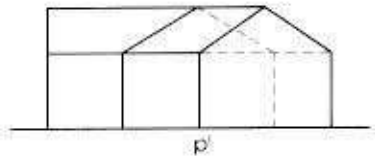

### Exercici 3 Opció B

