

# S2.1

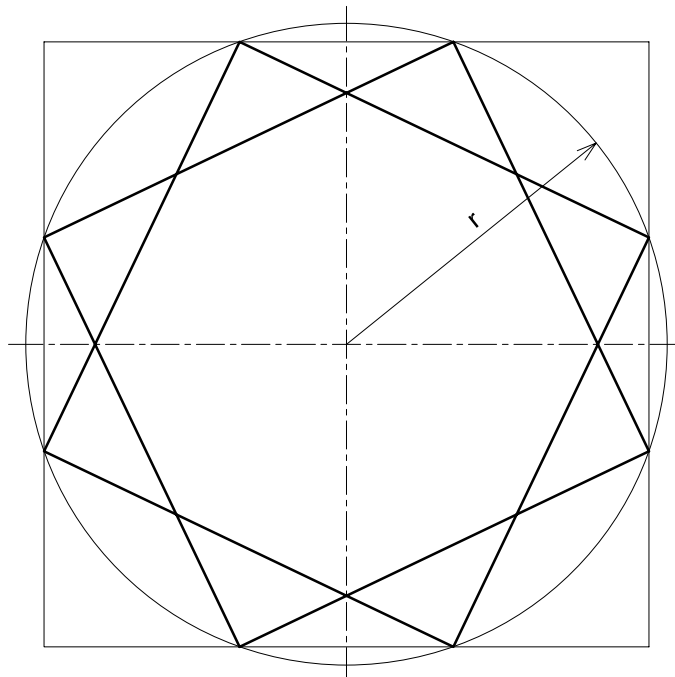

qualsevol dels dos quadrats és vàlid

S2.2A

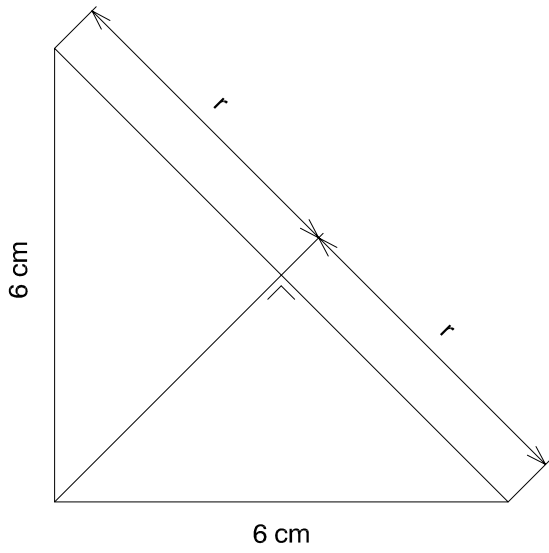
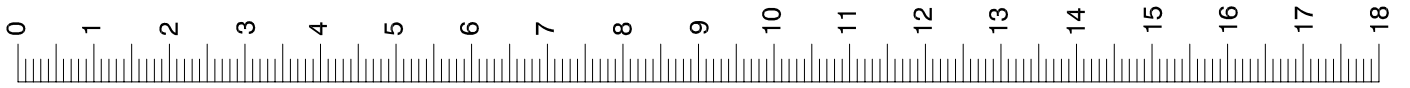
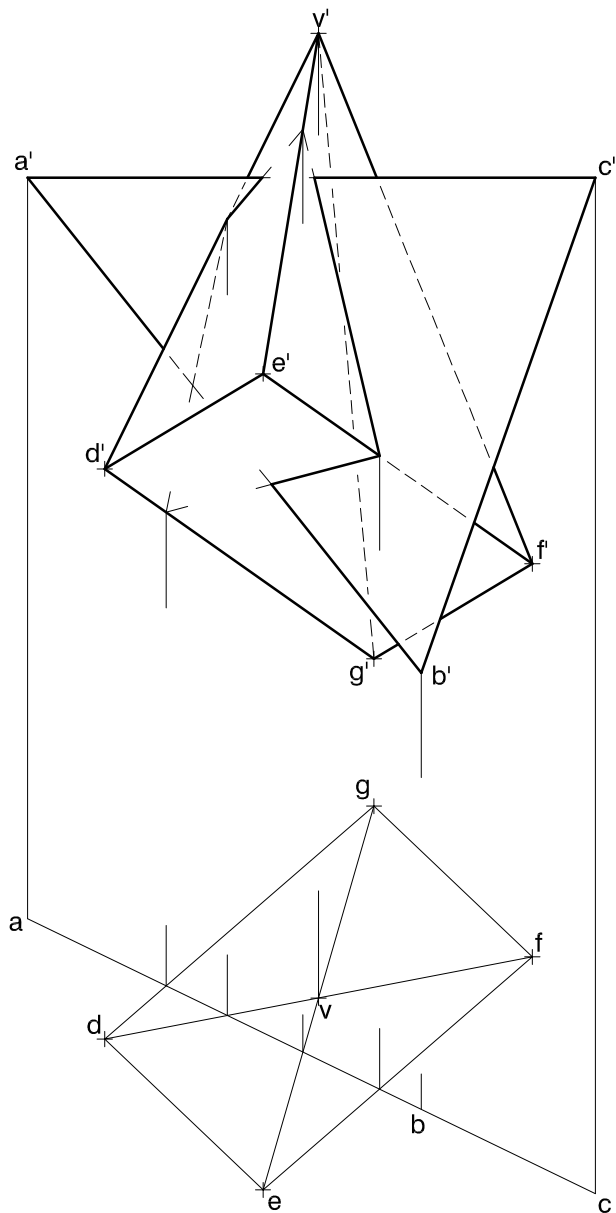

# S2.2B

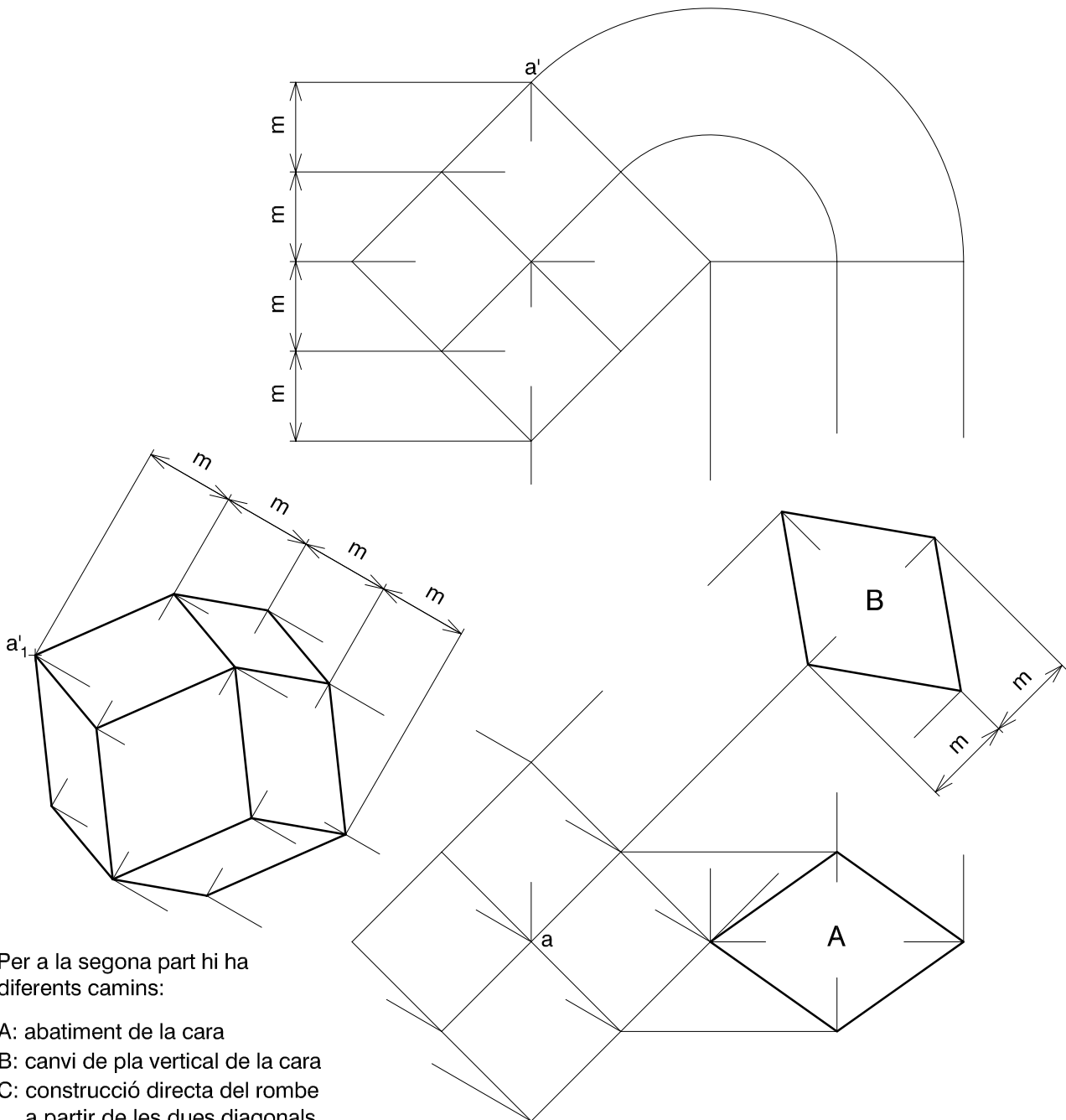

# S2.3A

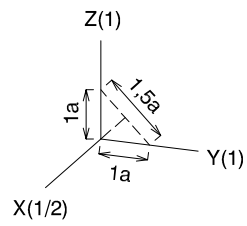
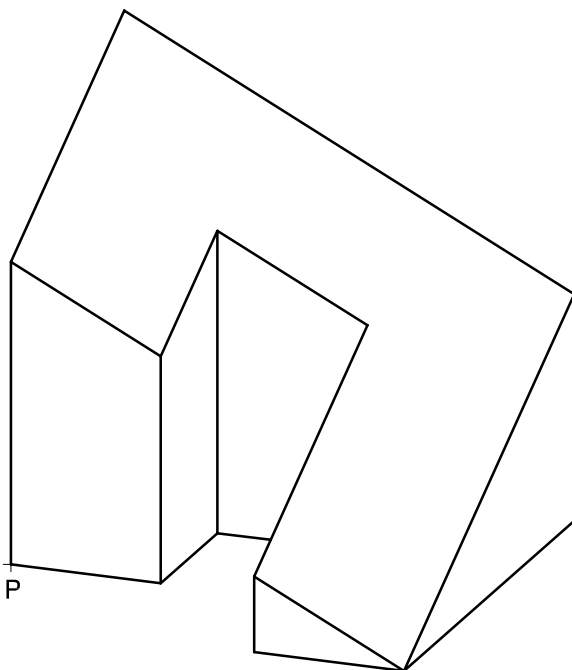
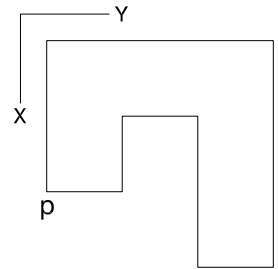
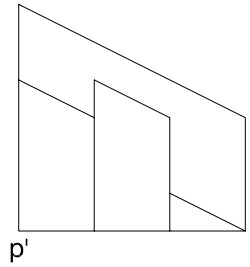
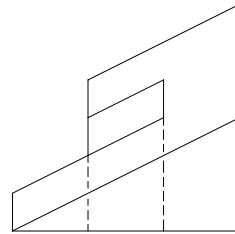
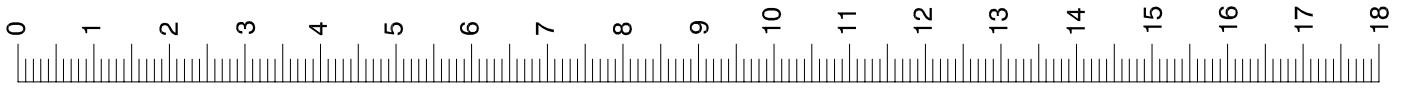

# S2.3B

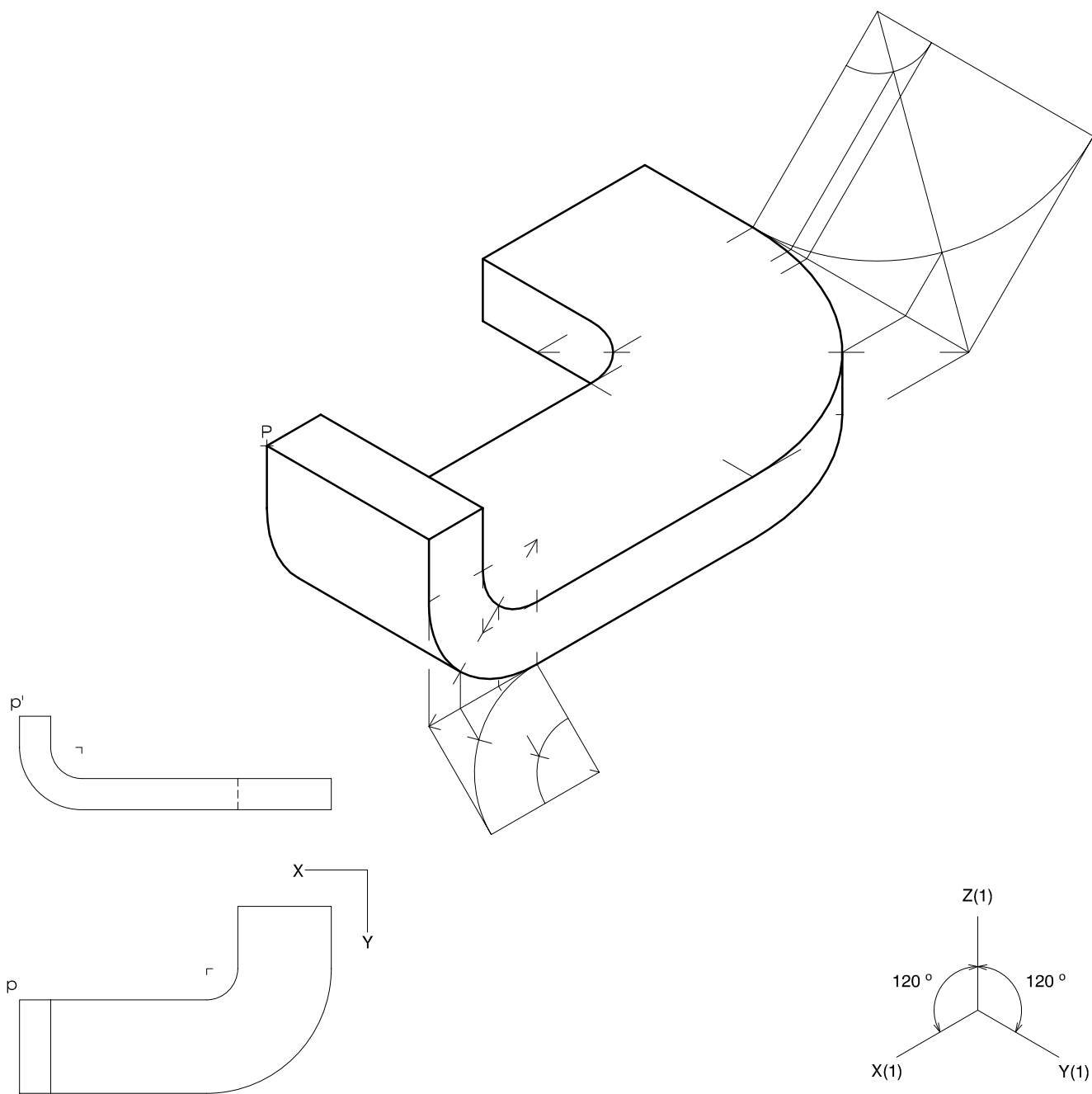

S1.1

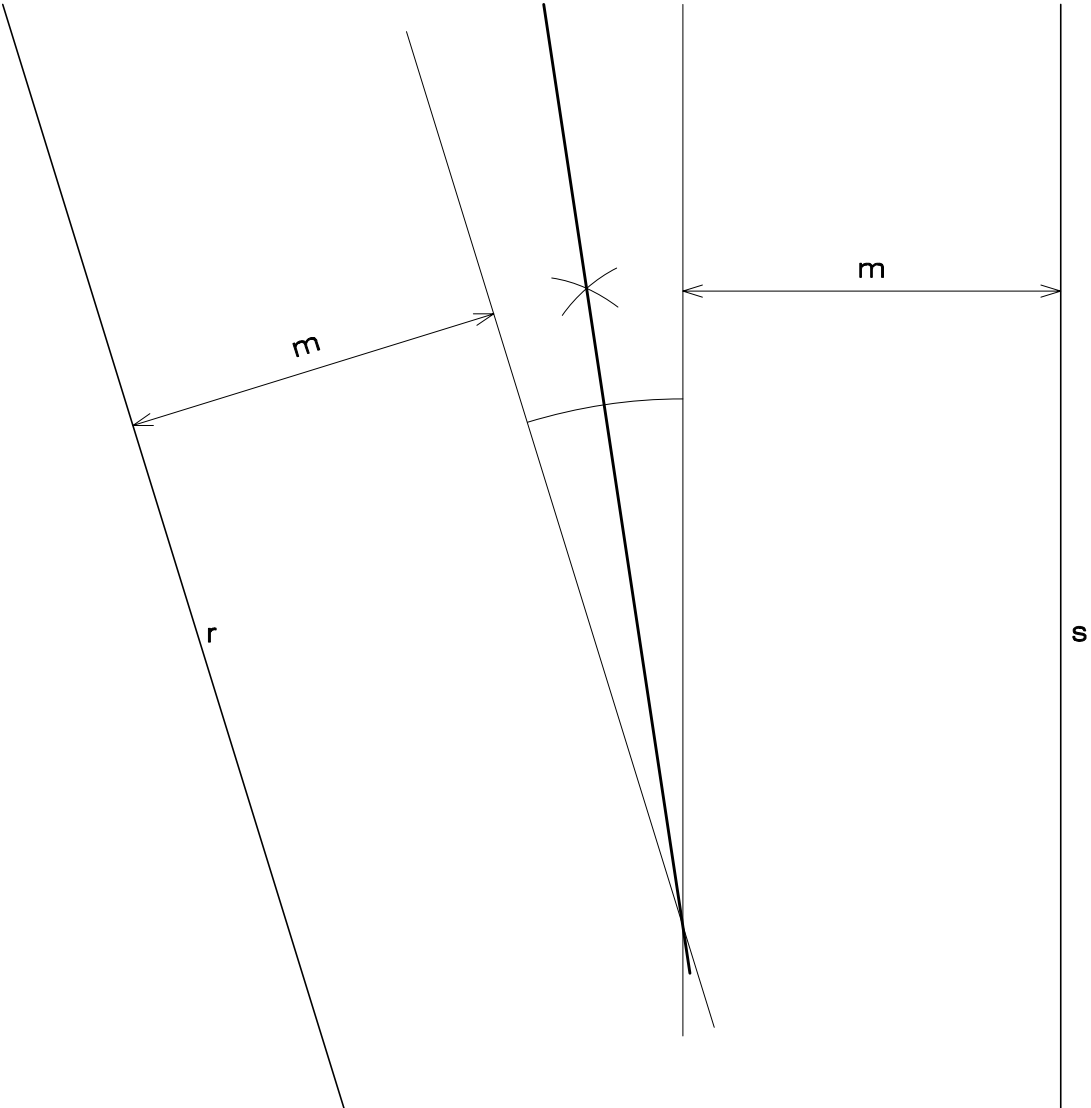

S1.2A

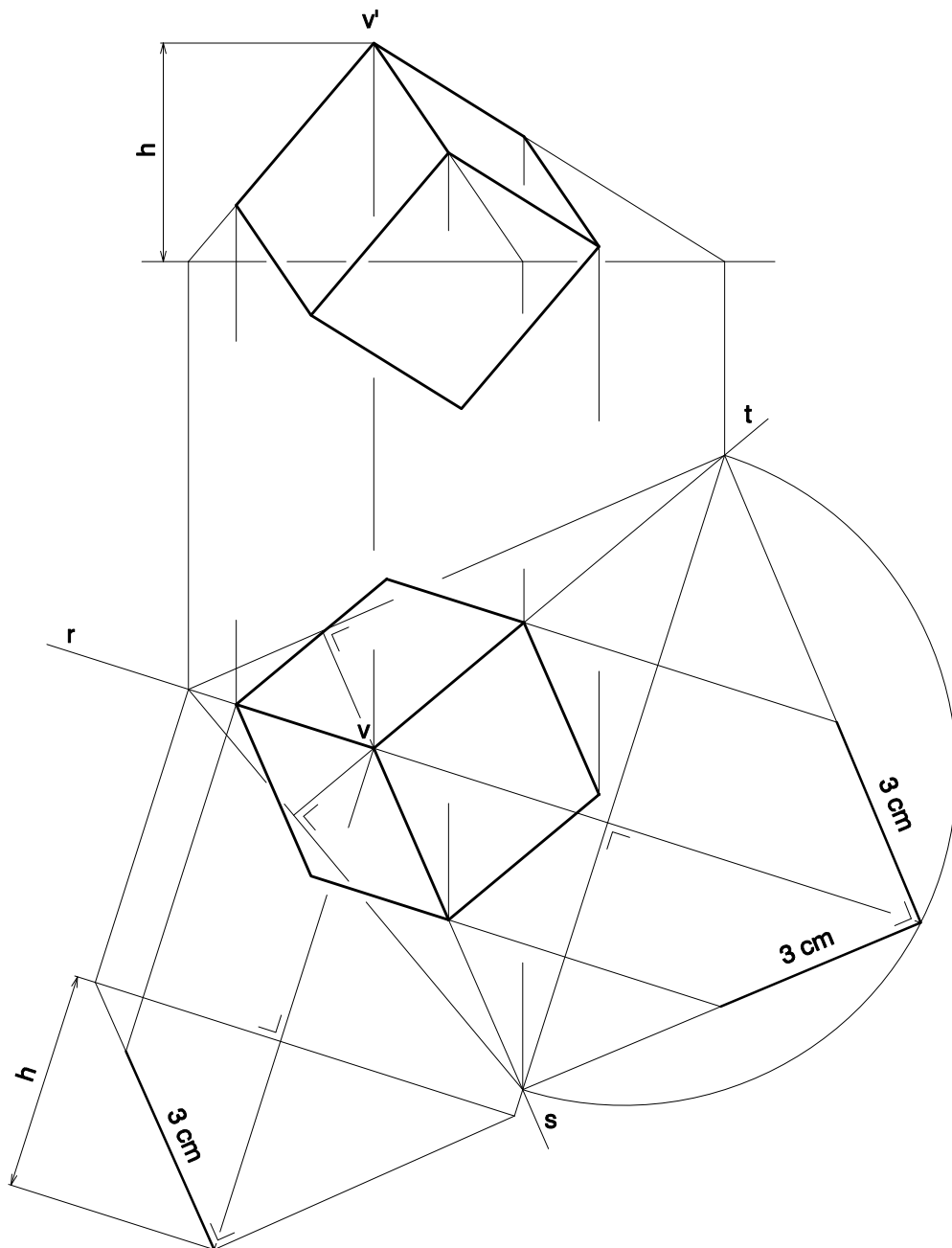

S1.2B

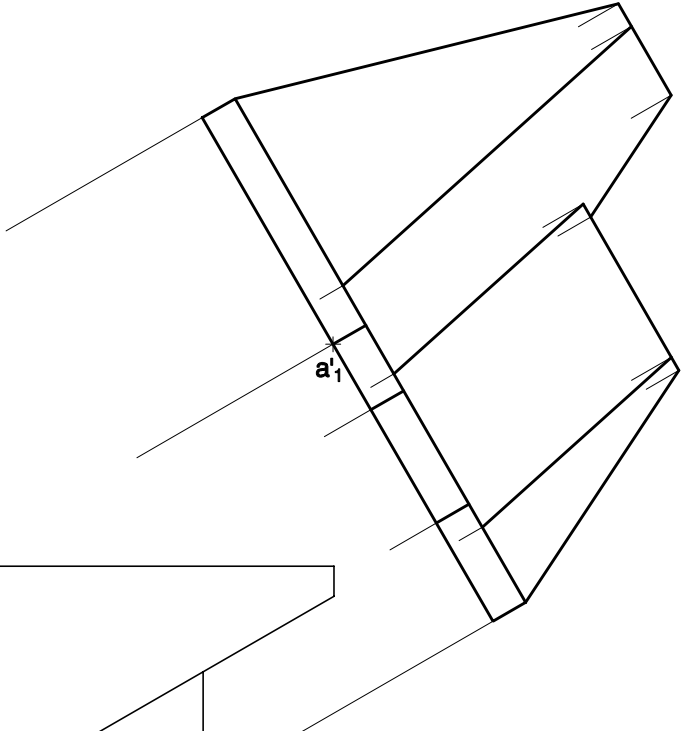
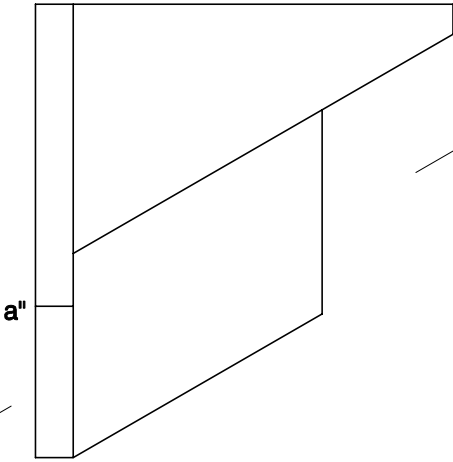
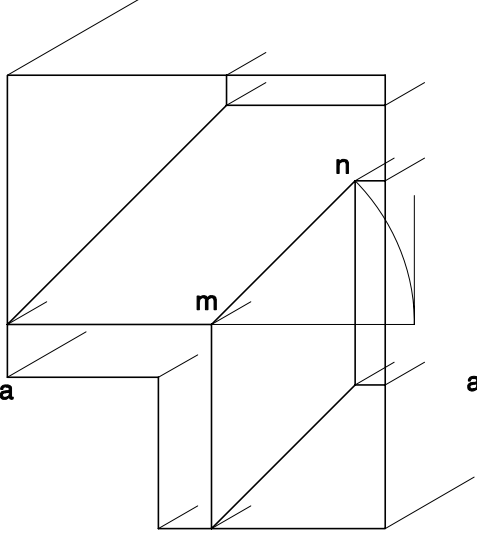
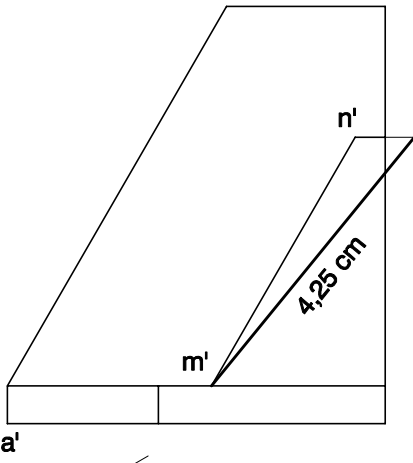



S1.3A

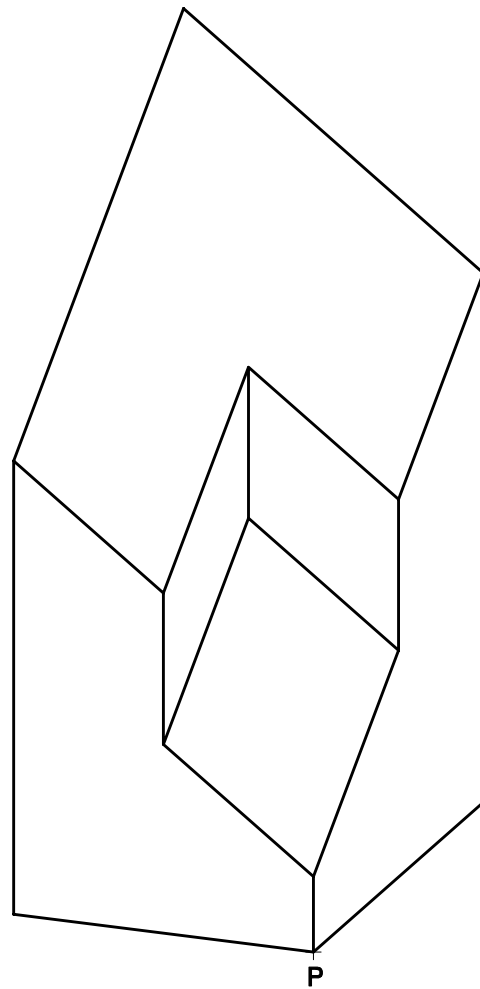
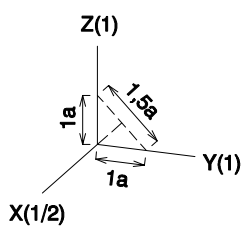
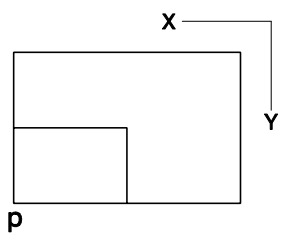
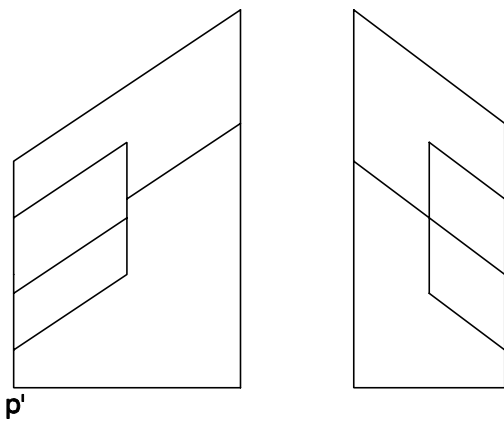

# S1.3B

