

SÈRIE 2

2-1

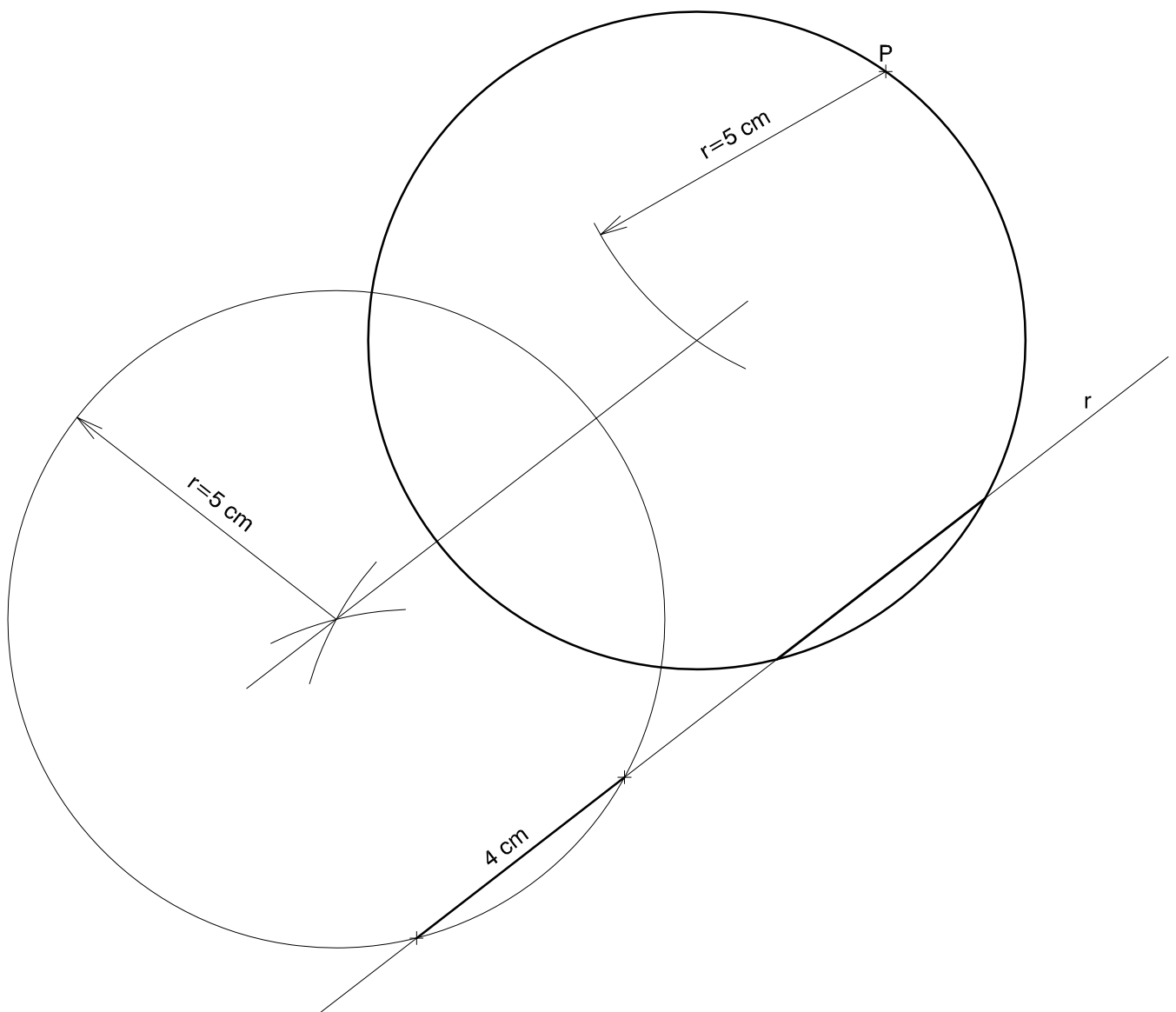

2-2A

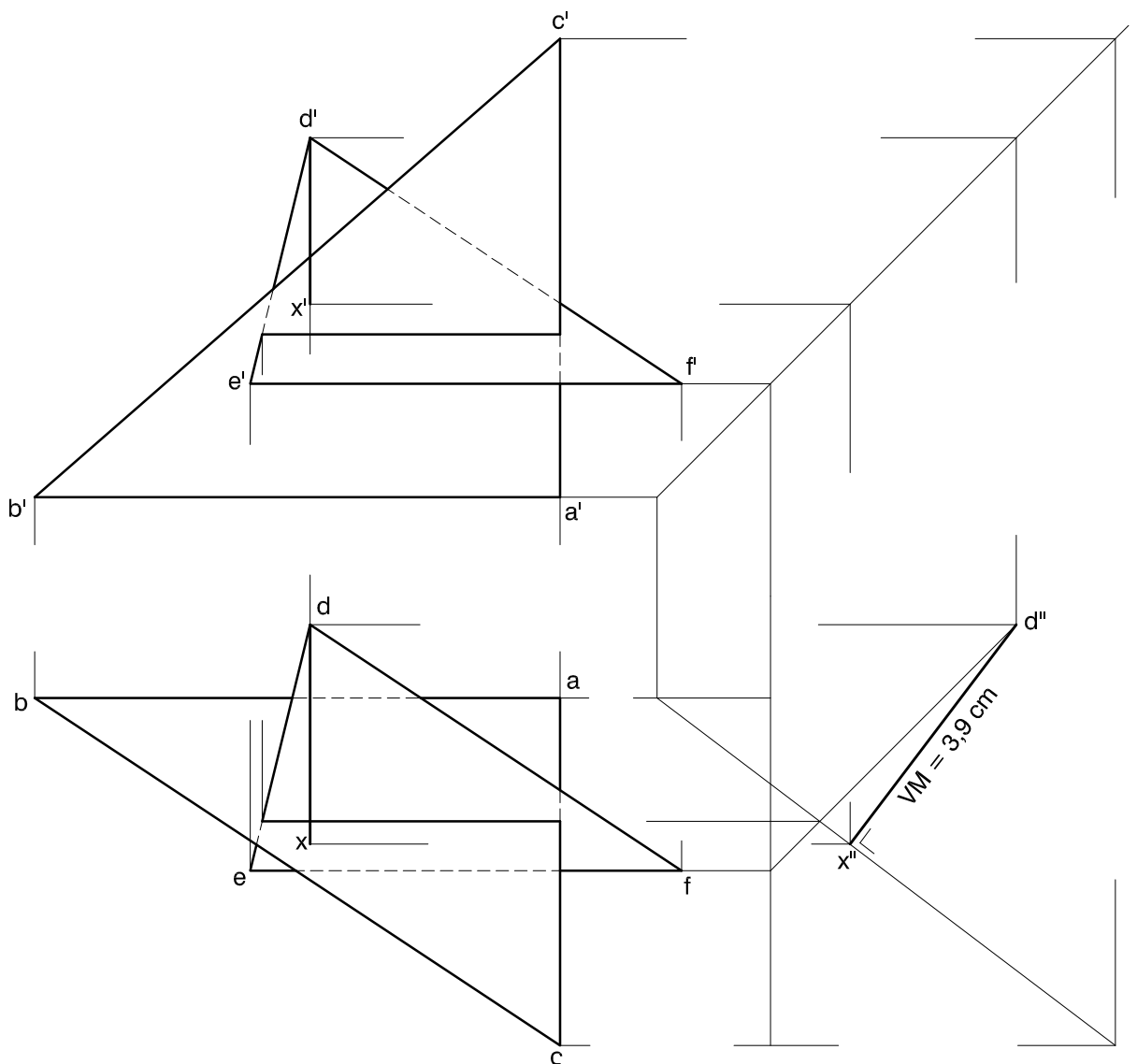
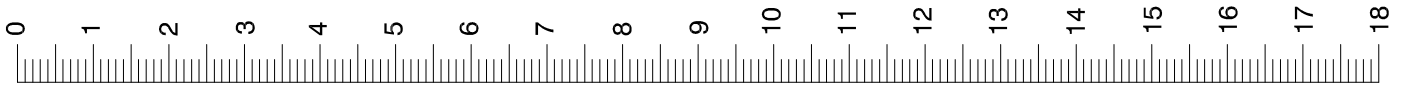

2-2B

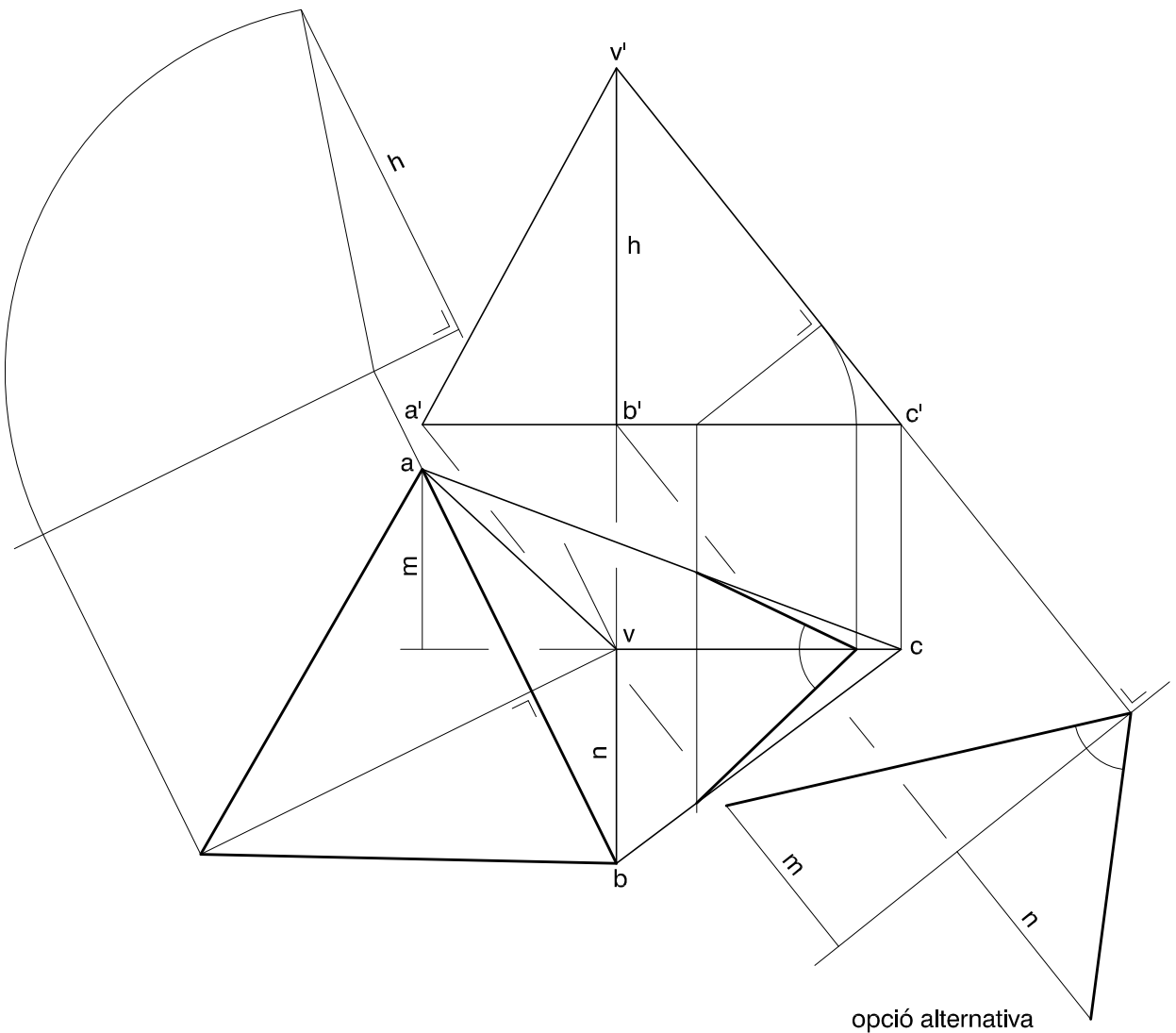
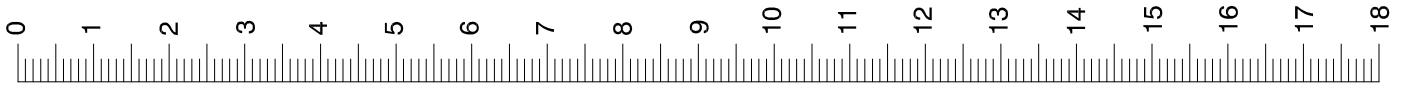

2-3A

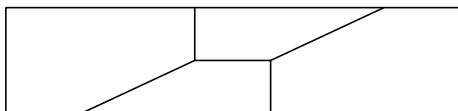
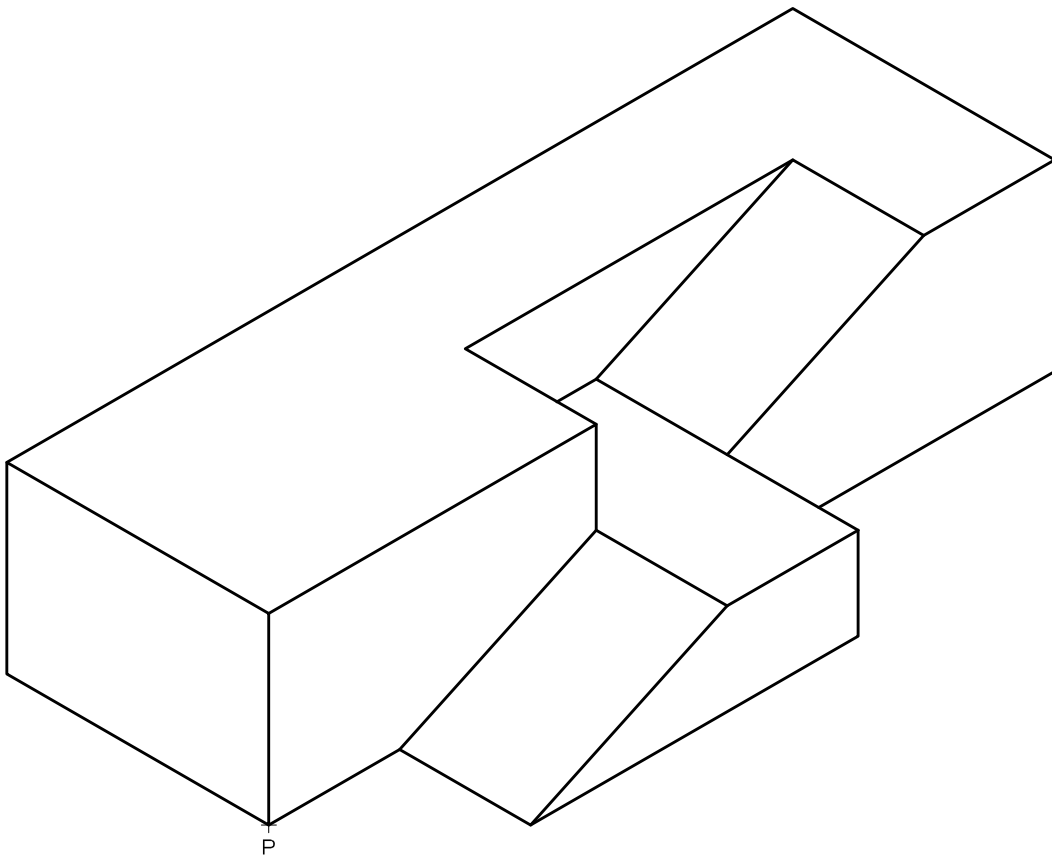
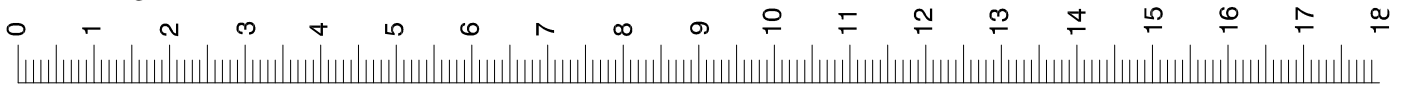

p'

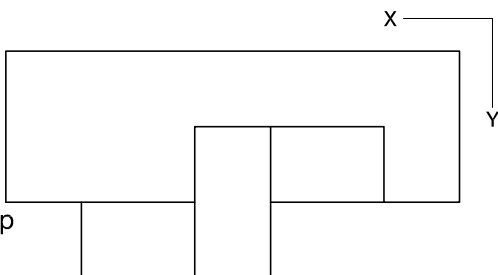

p

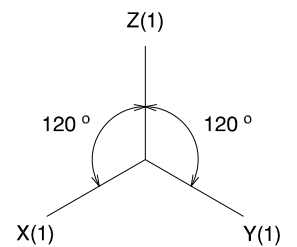

2-3B

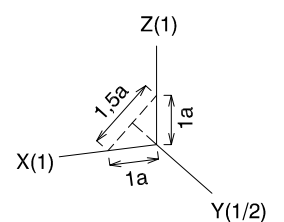
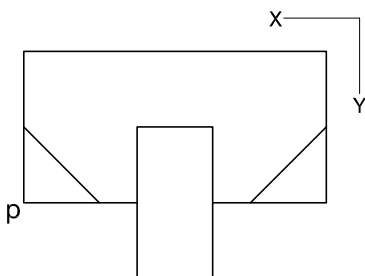
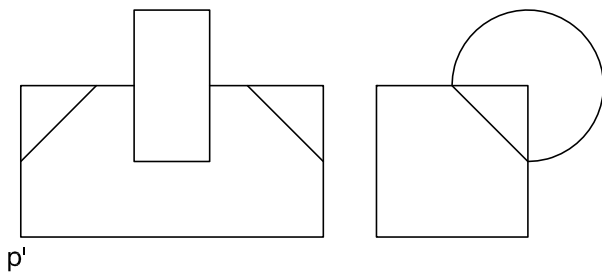
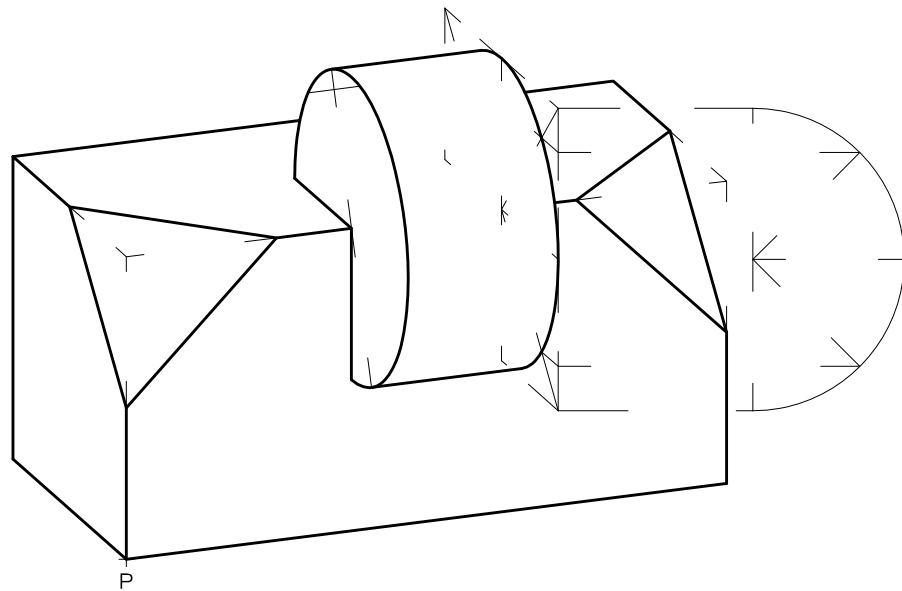
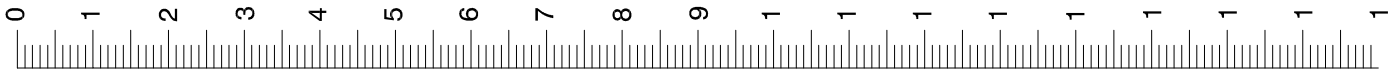

## SÈRIE 5

5-1

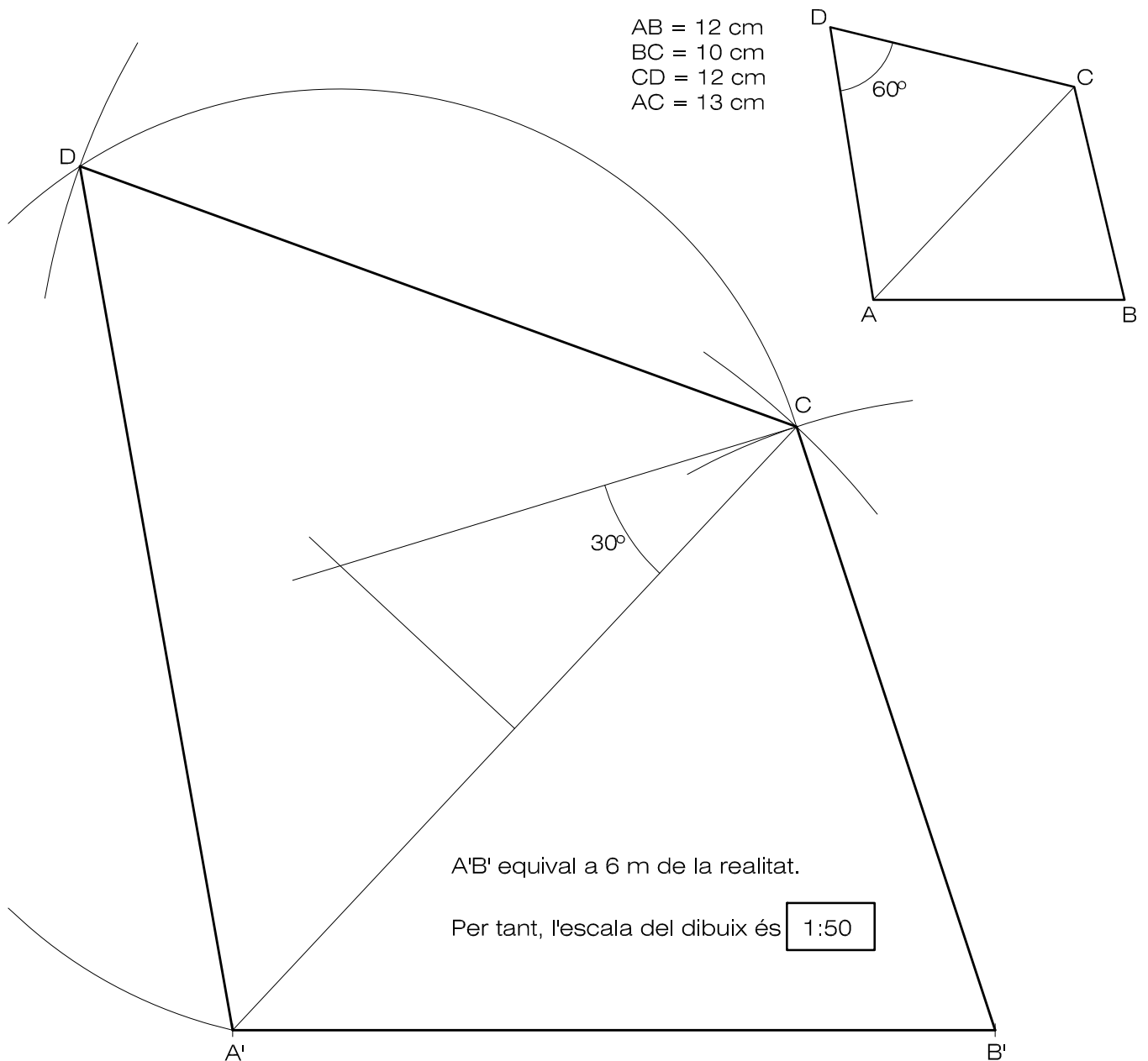

5-2A

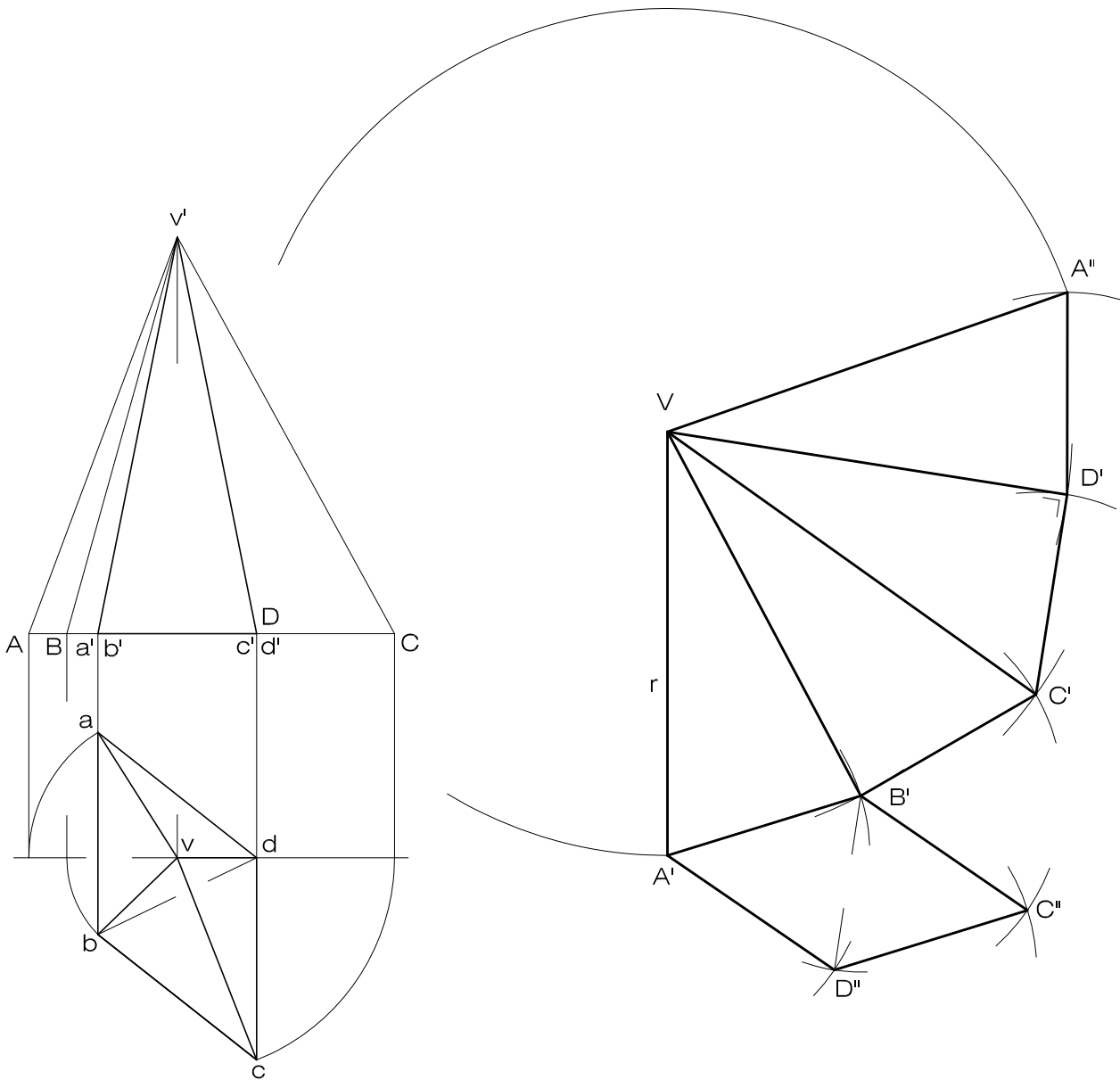

5-2B

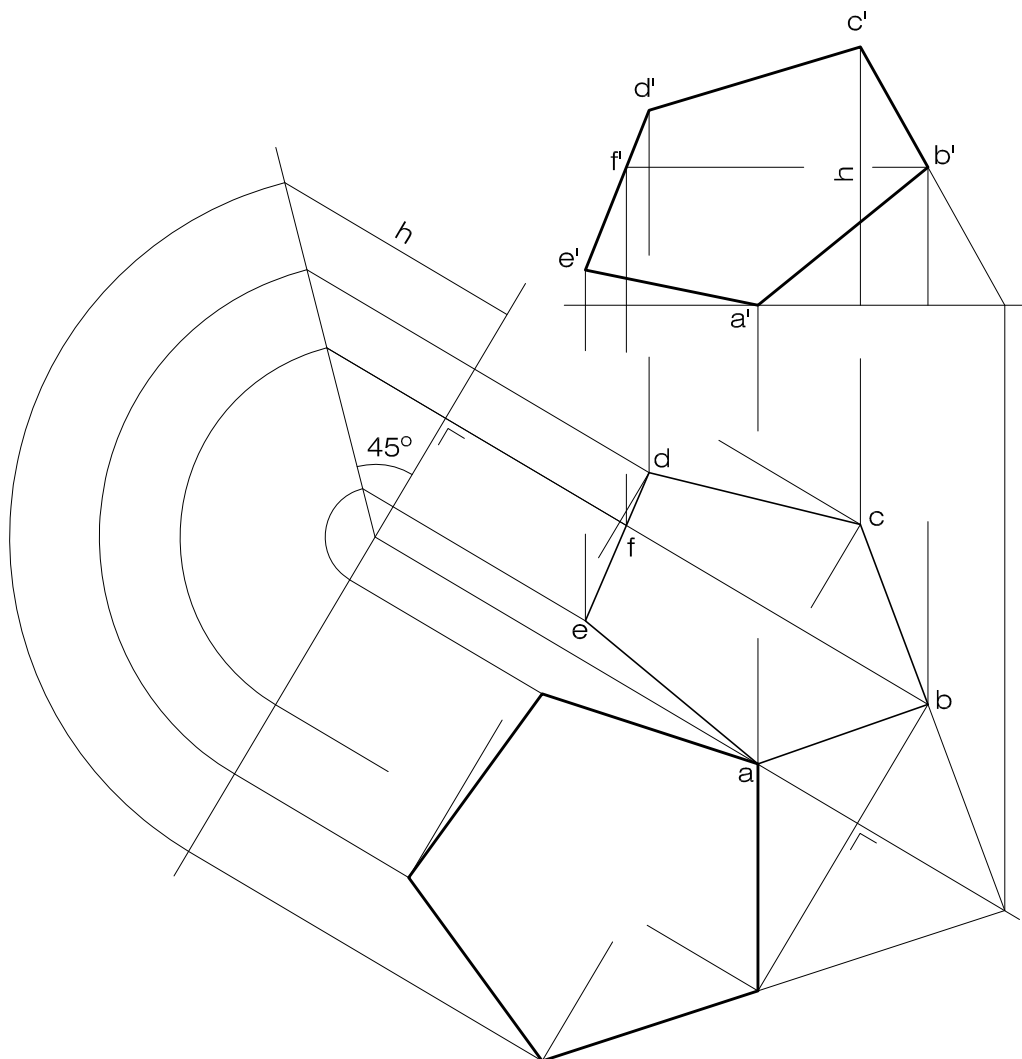



S5.3A

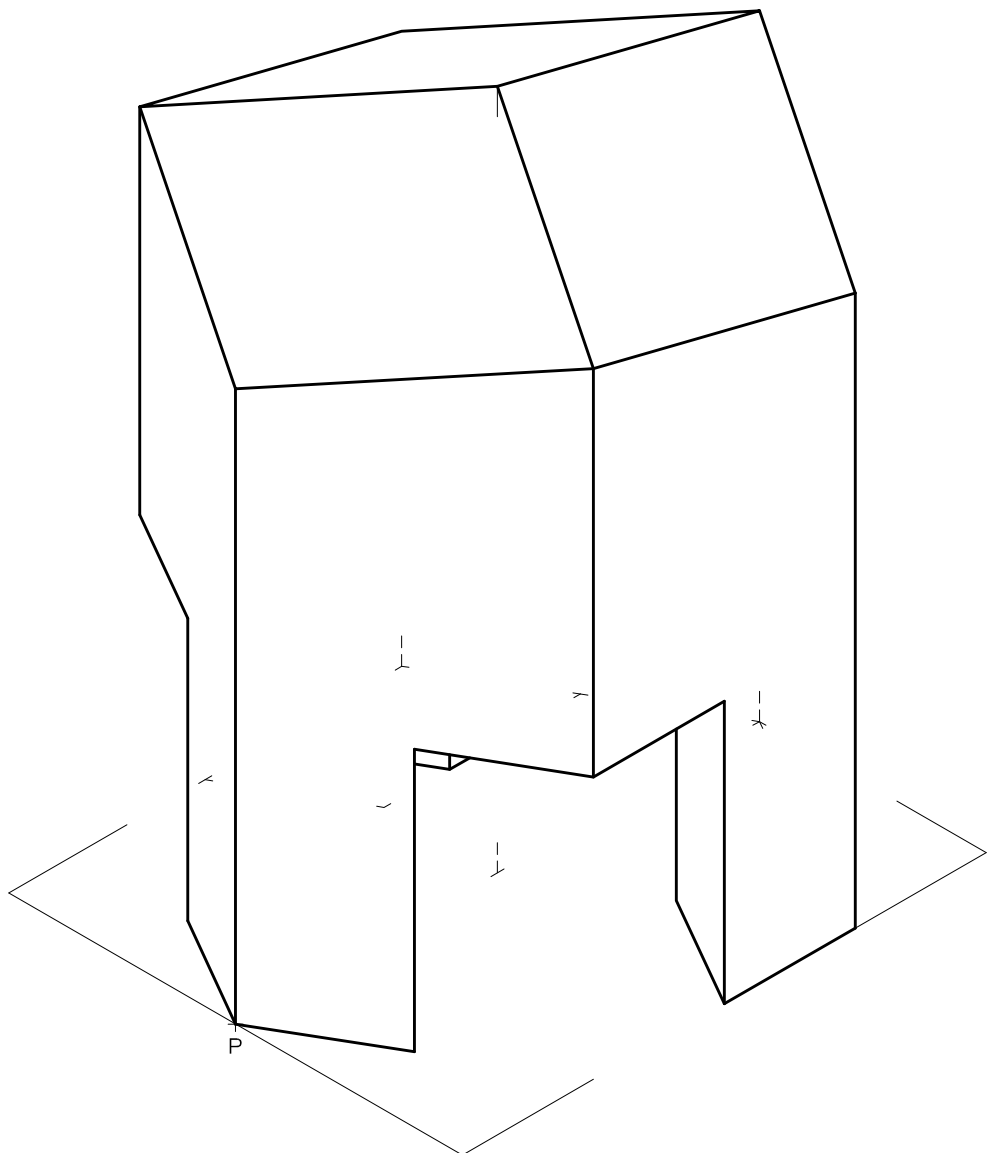
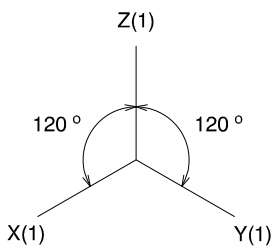
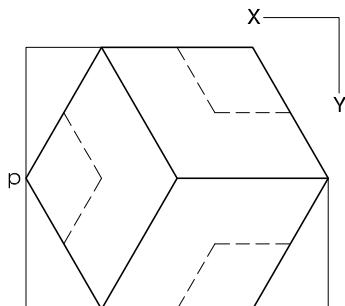
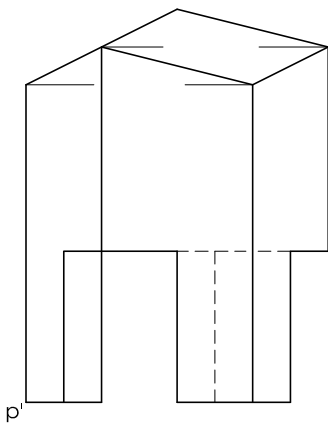
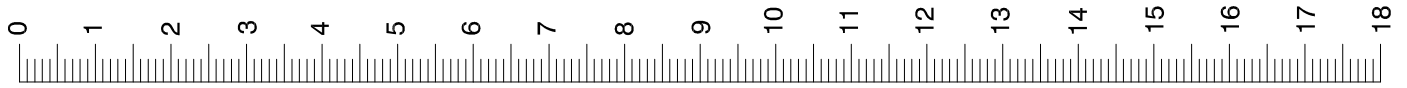

5-3B

