

SÈRIE 4

S4.1A

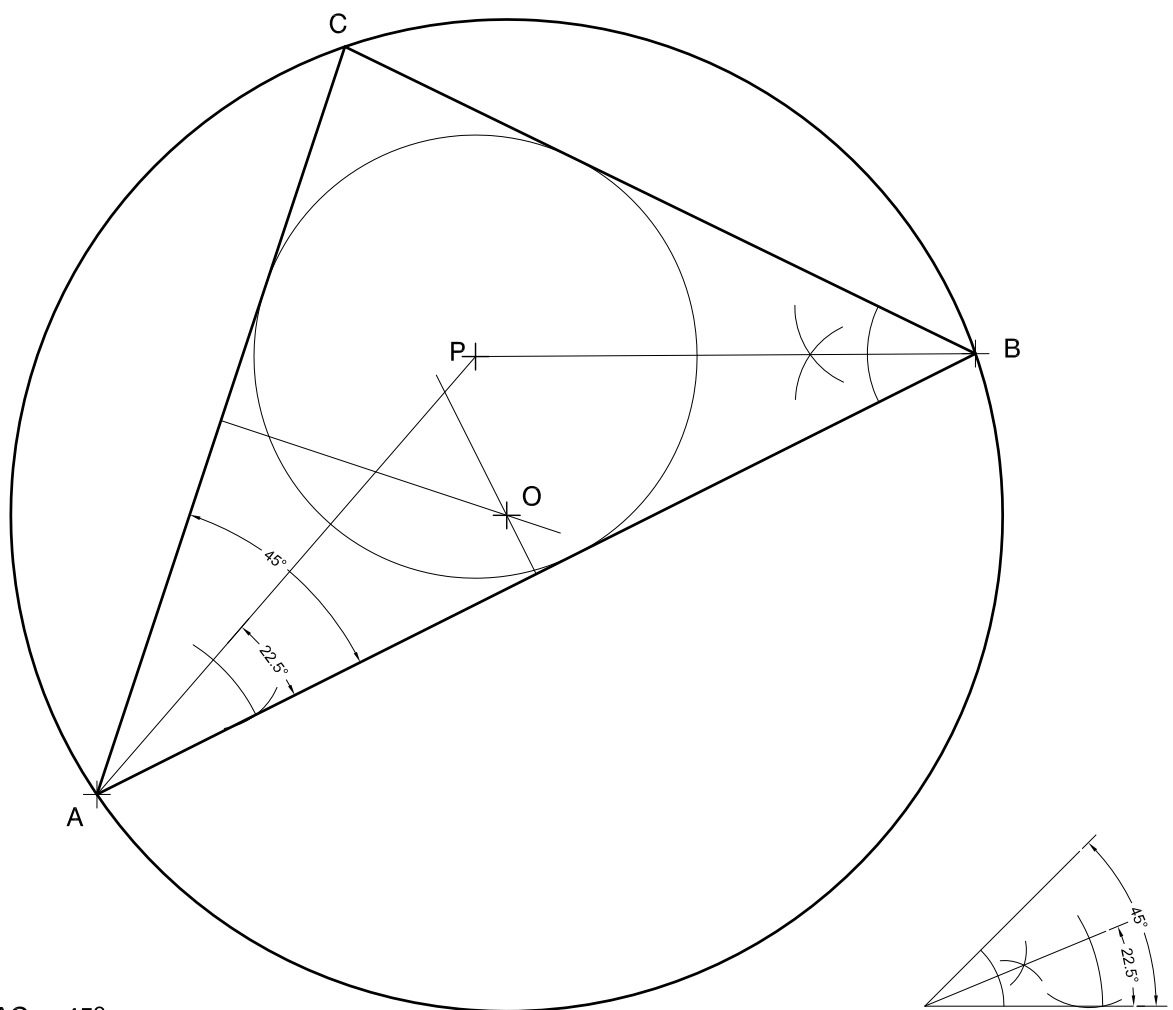
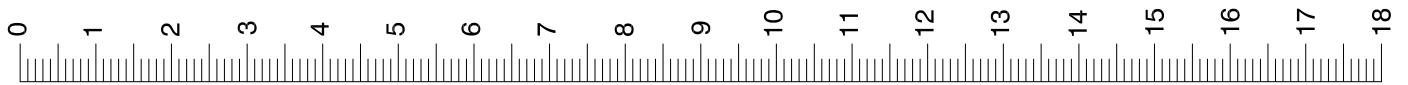

Angle BAC = 45°

A ————— B

S4.1B

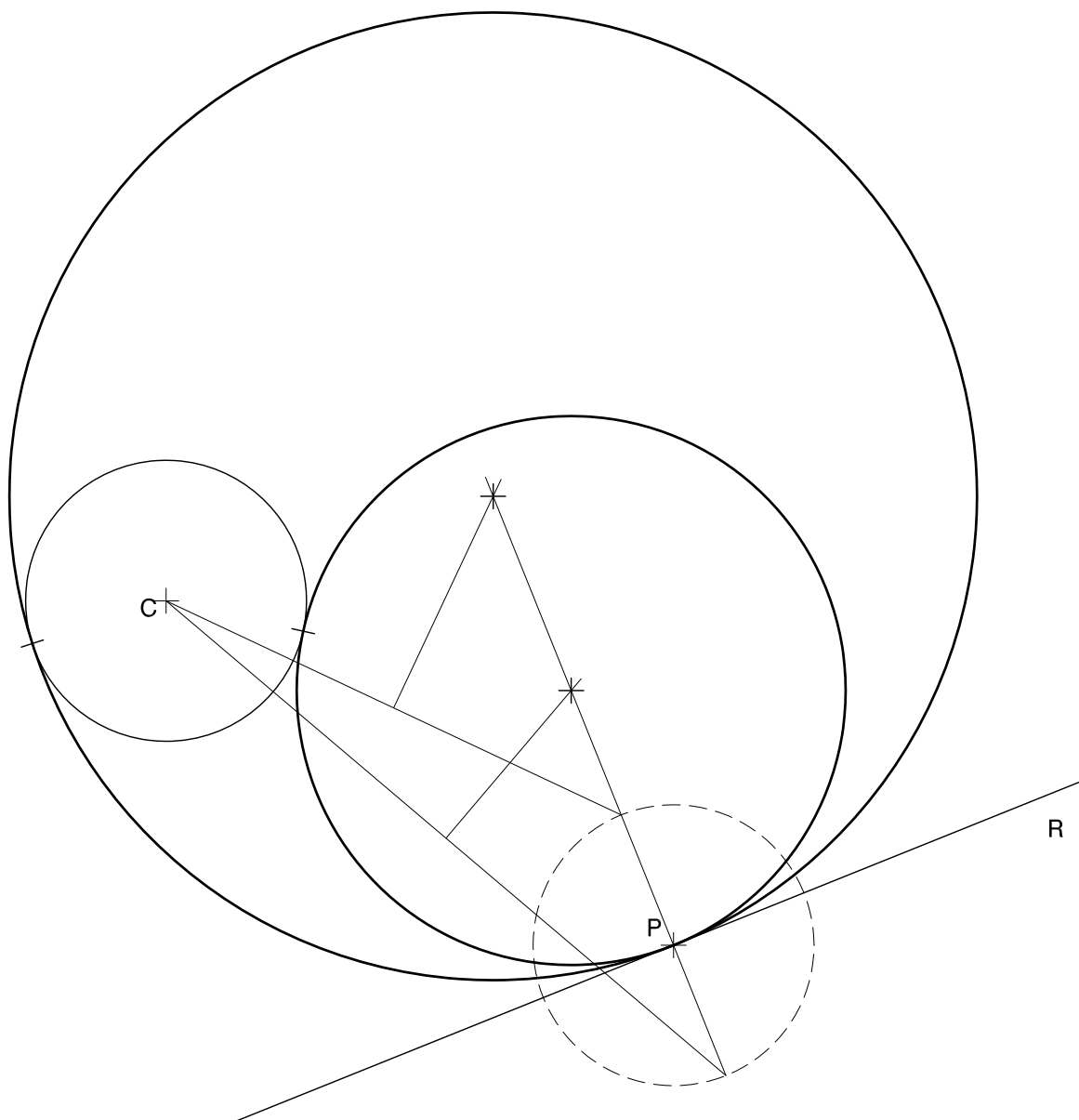
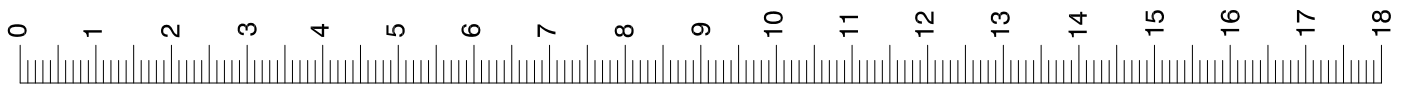

S4.2A

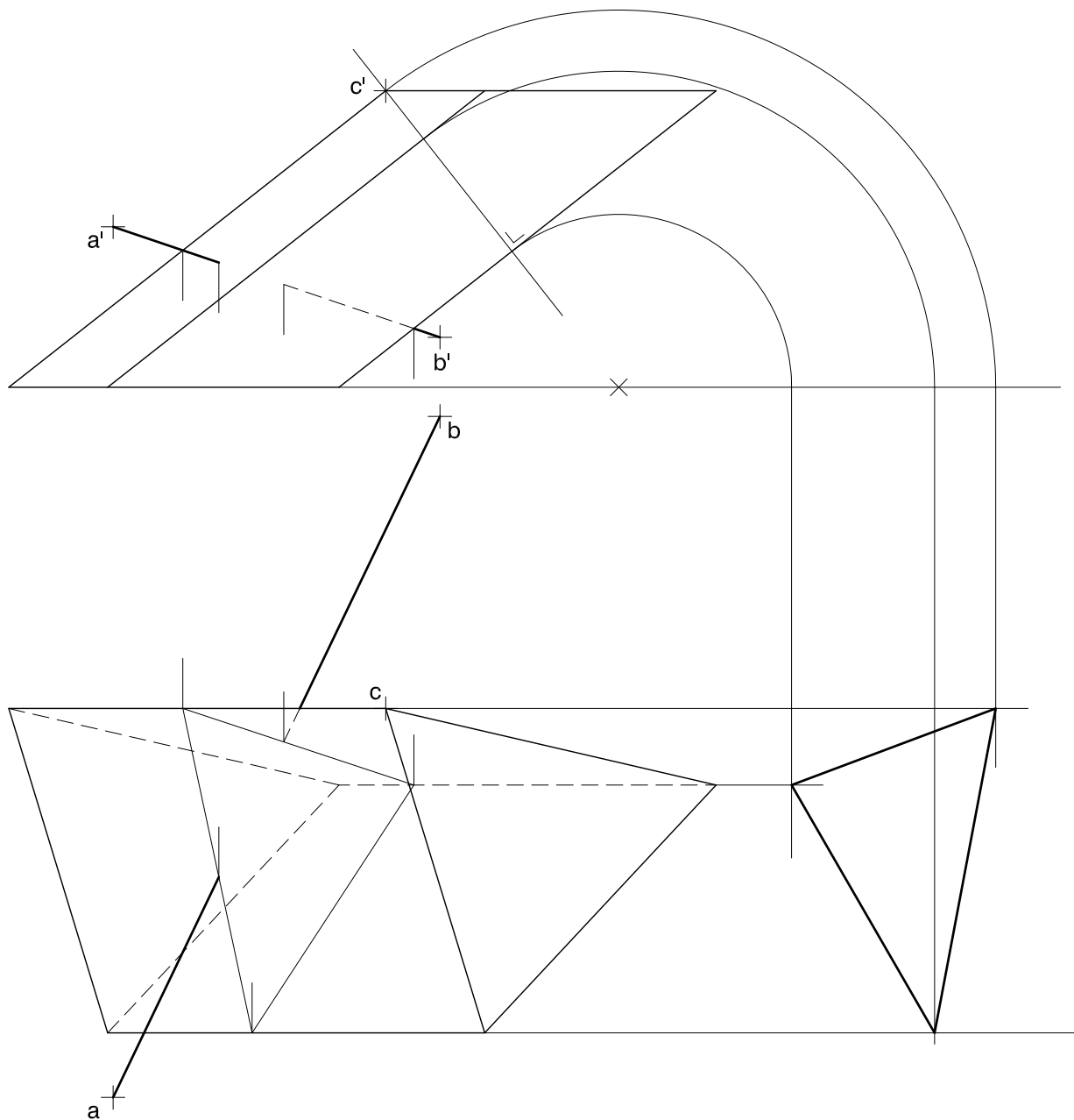

S4.2B

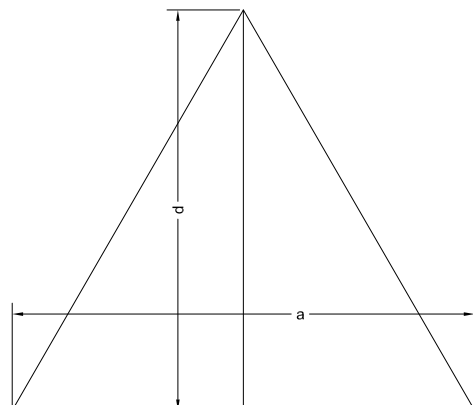
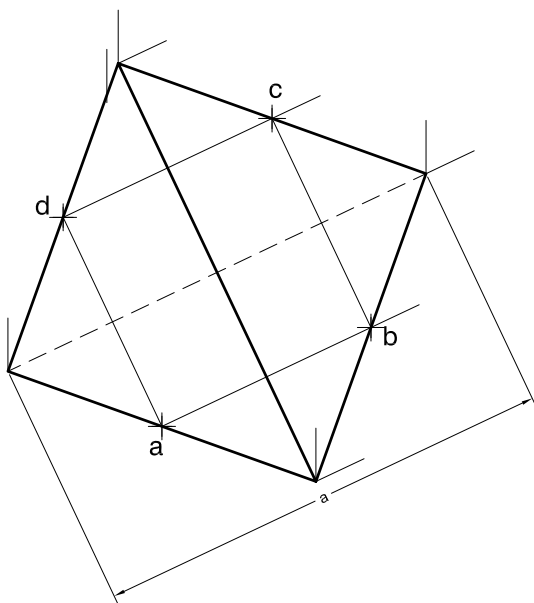
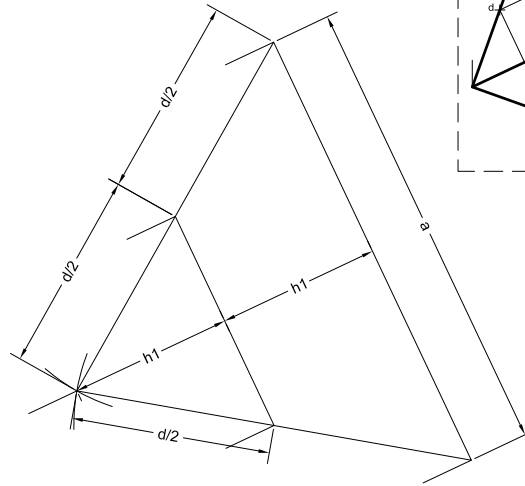
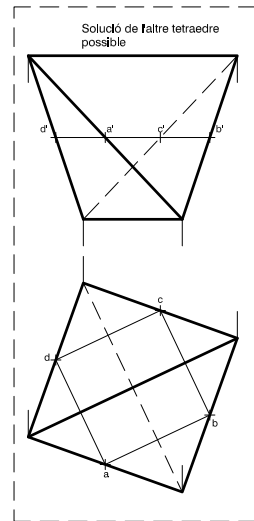
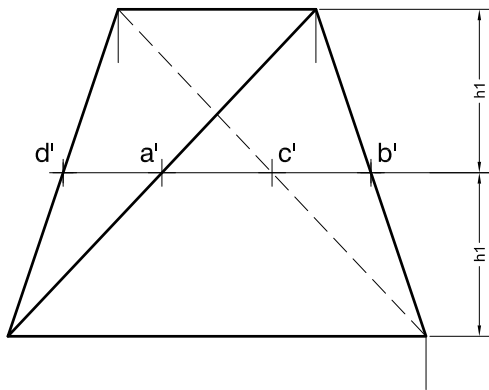
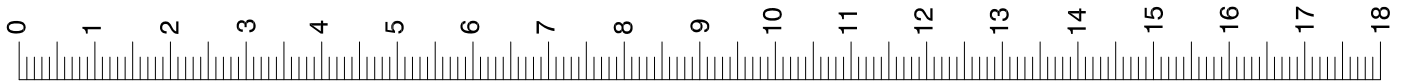

S4.3A

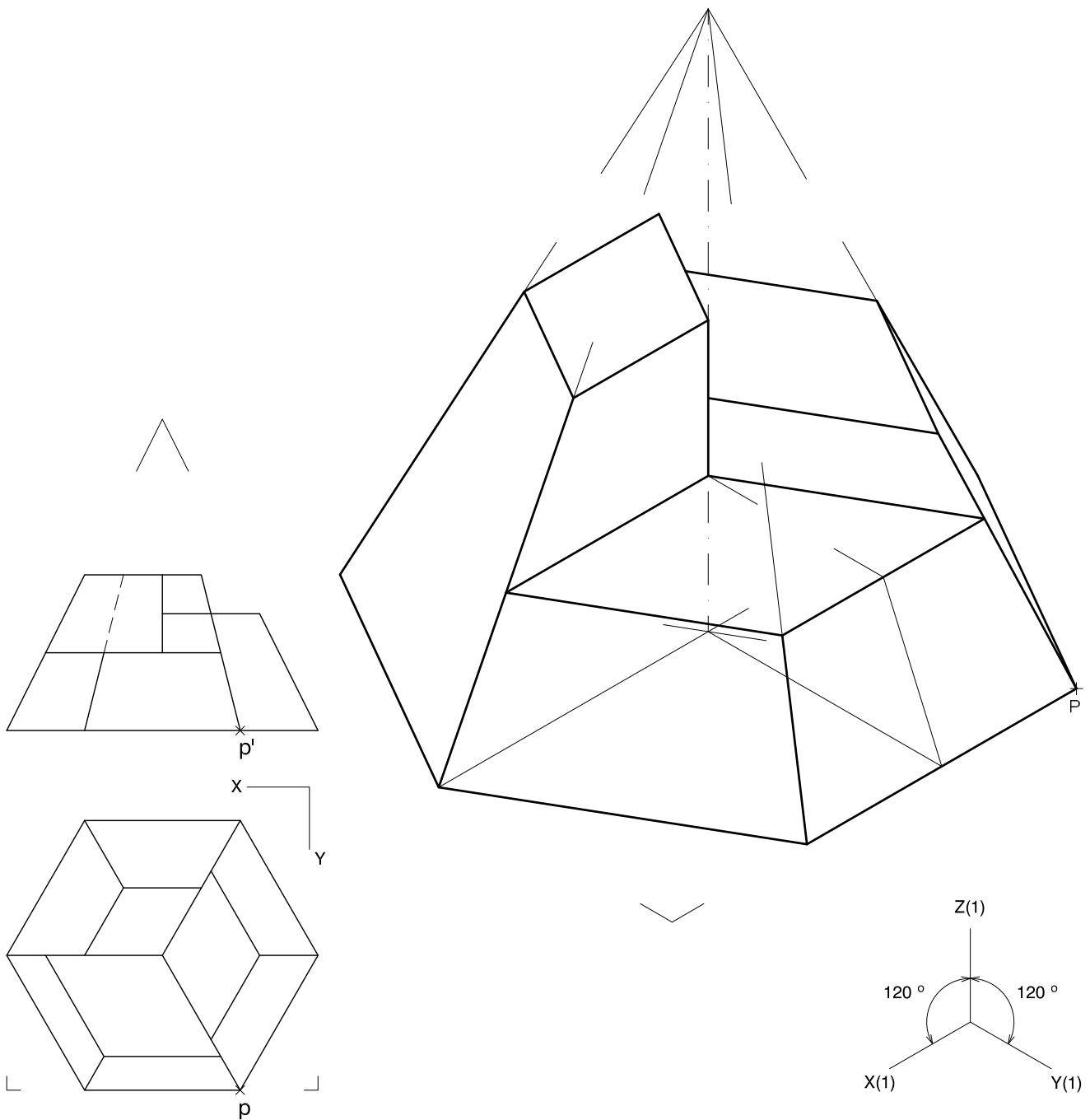
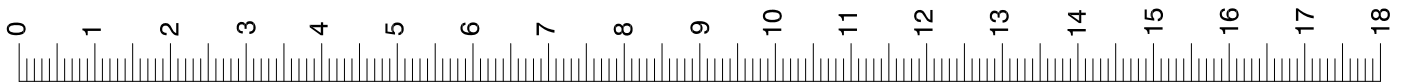

S4.3B

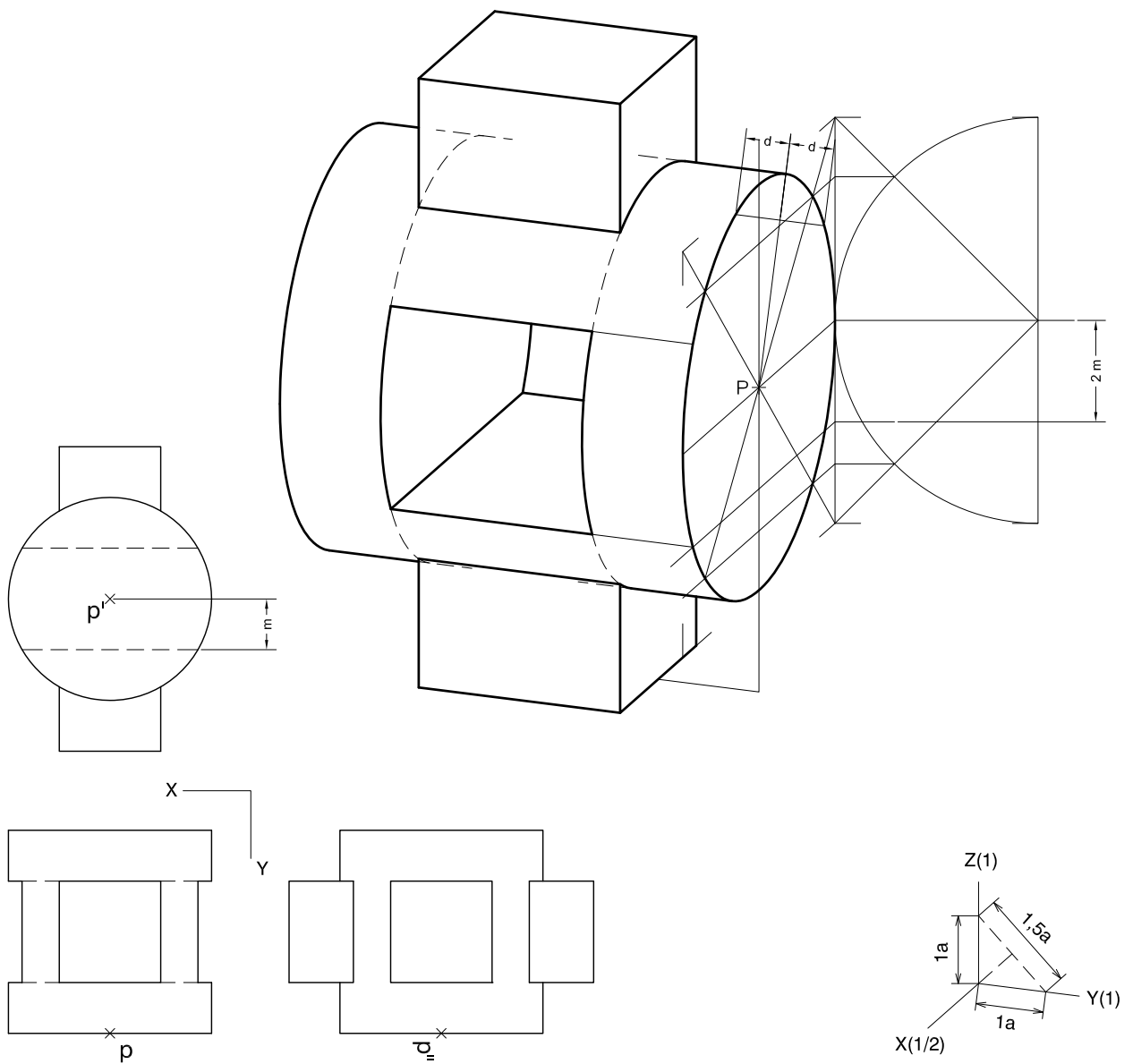
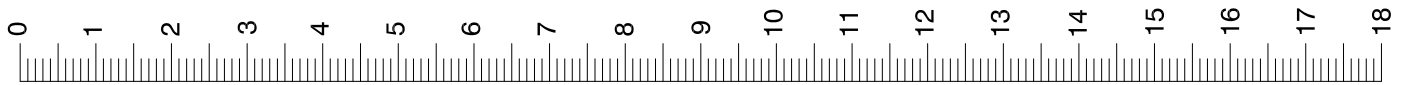

SÈRIE 3

S3.1A

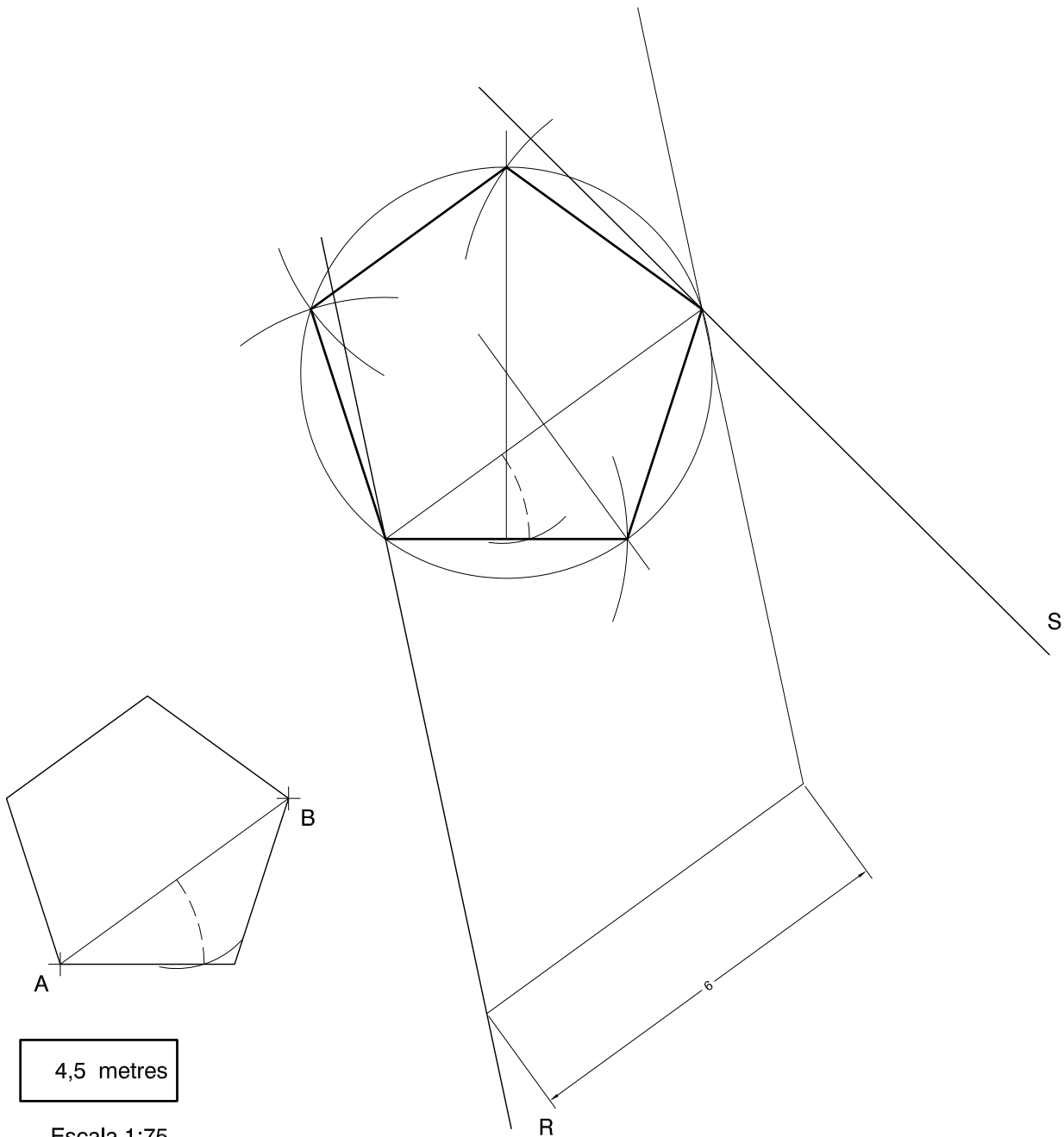
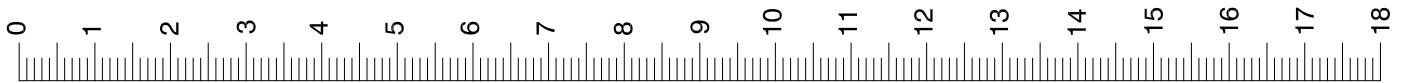

S3.1B

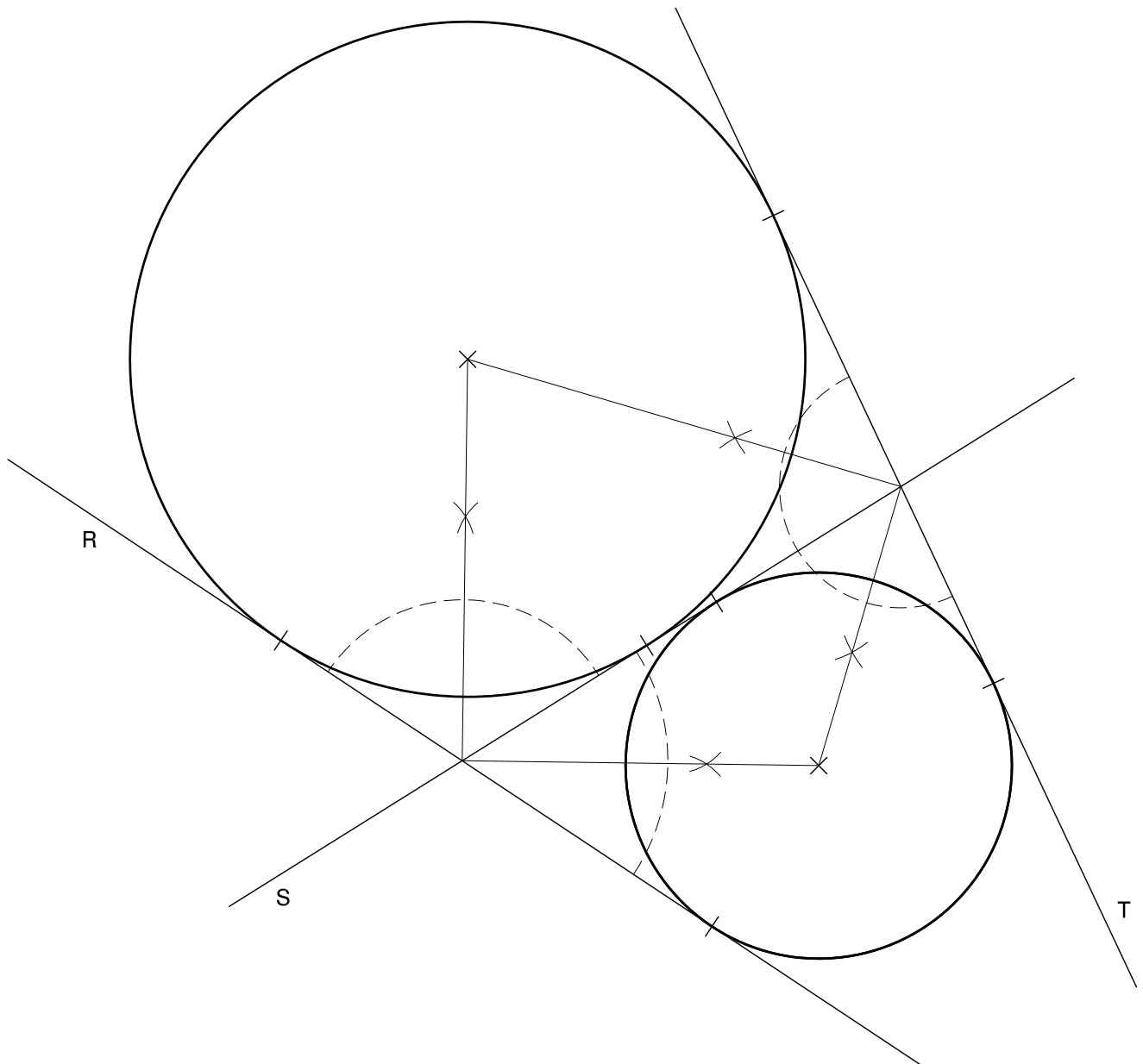
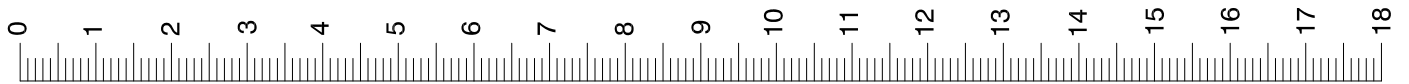

S3.2A

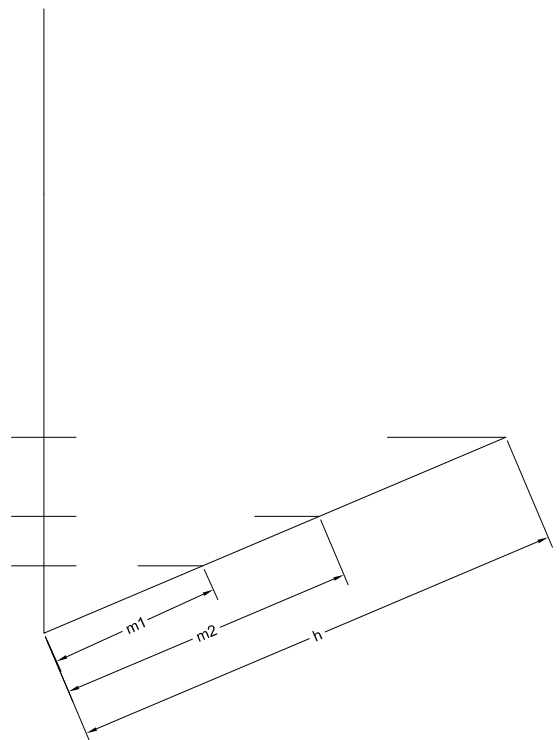
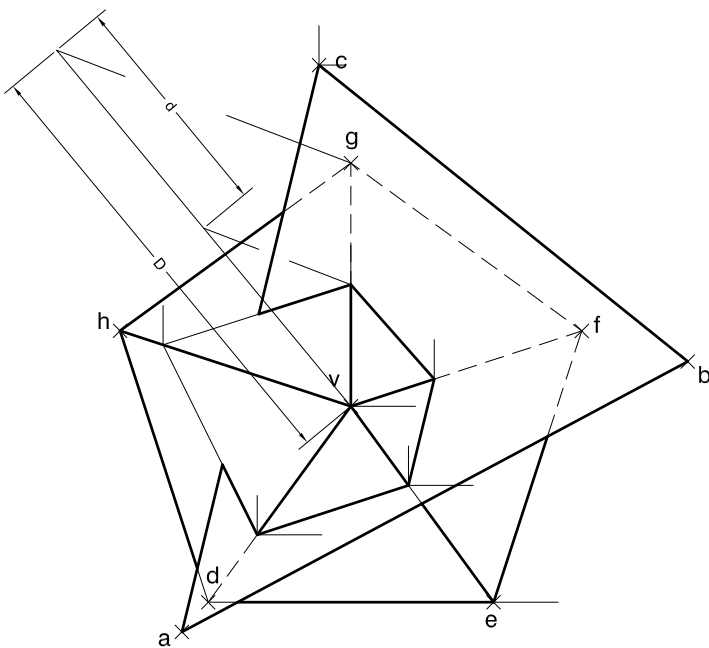
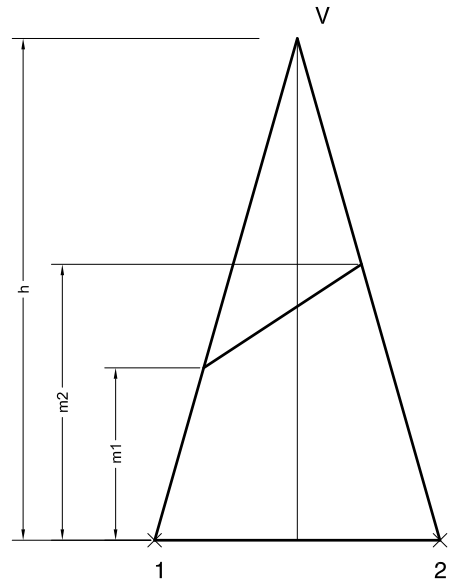
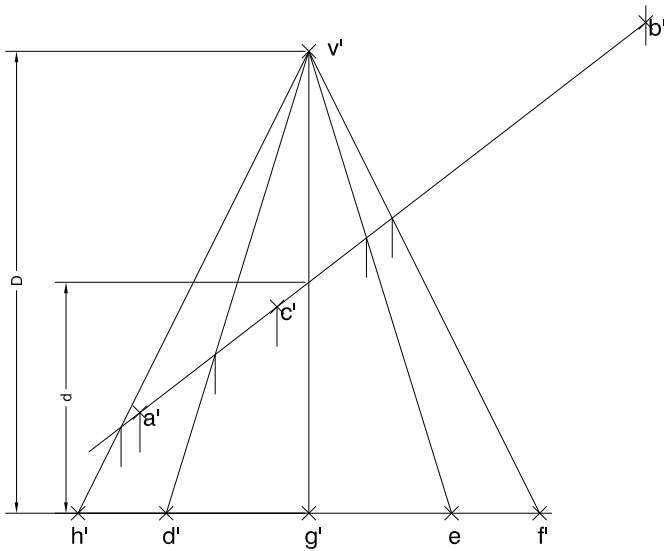
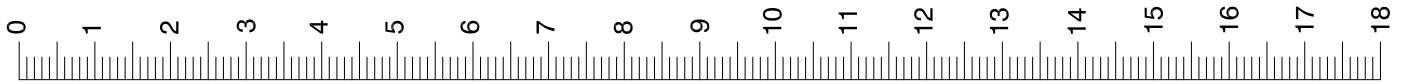

S3.2B

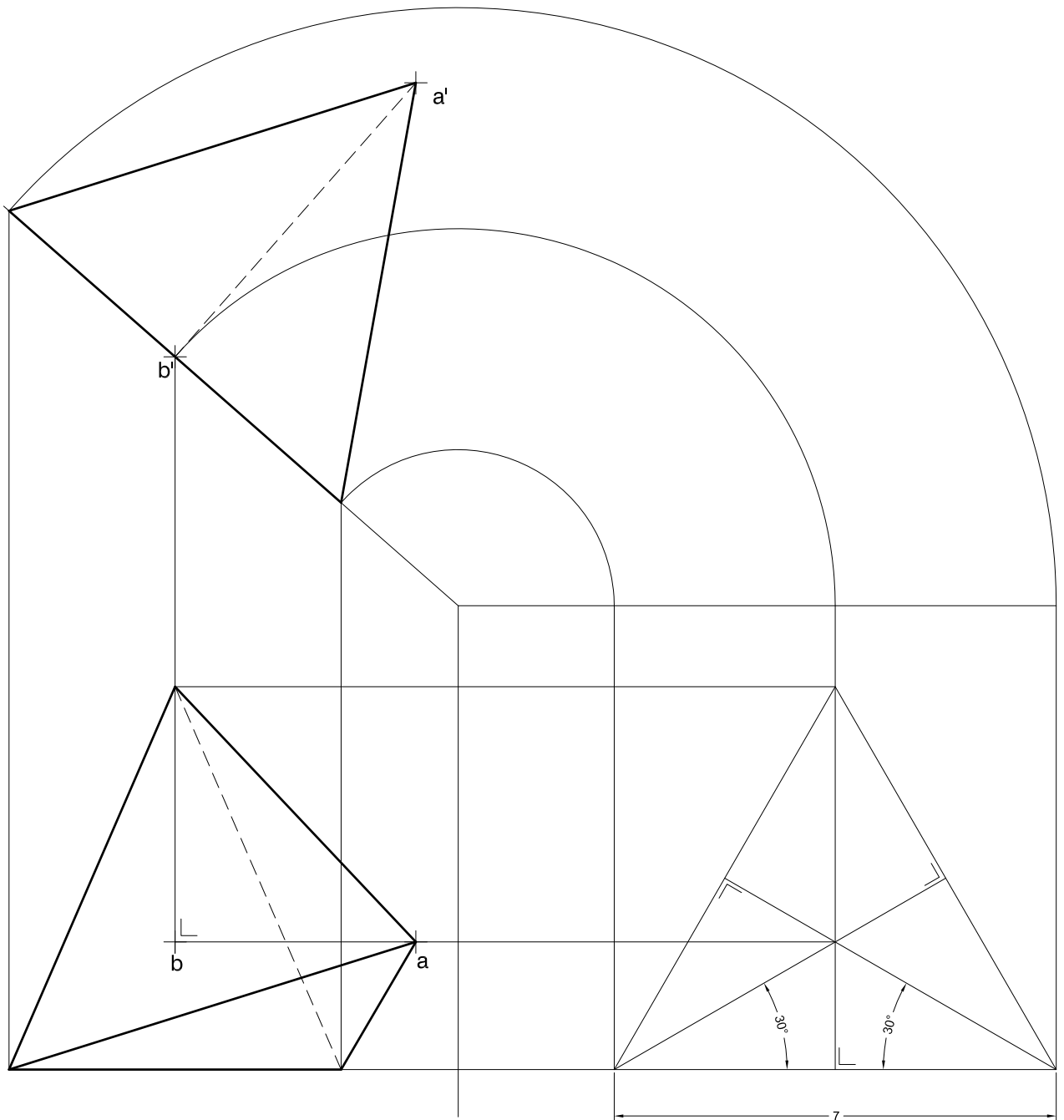
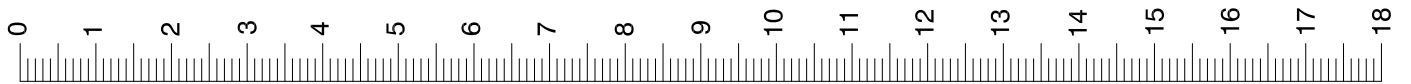

S3.3A

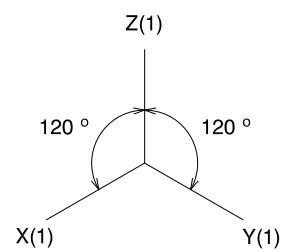
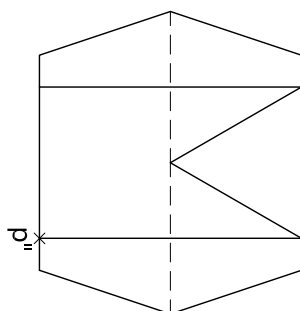
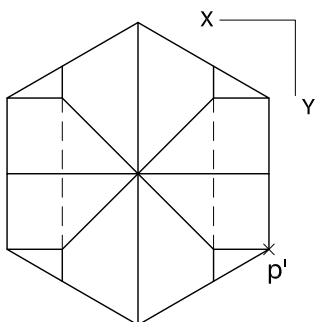
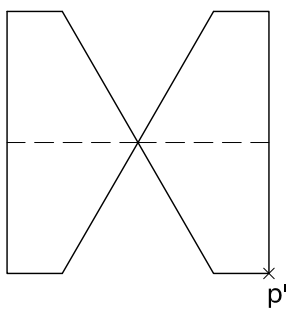
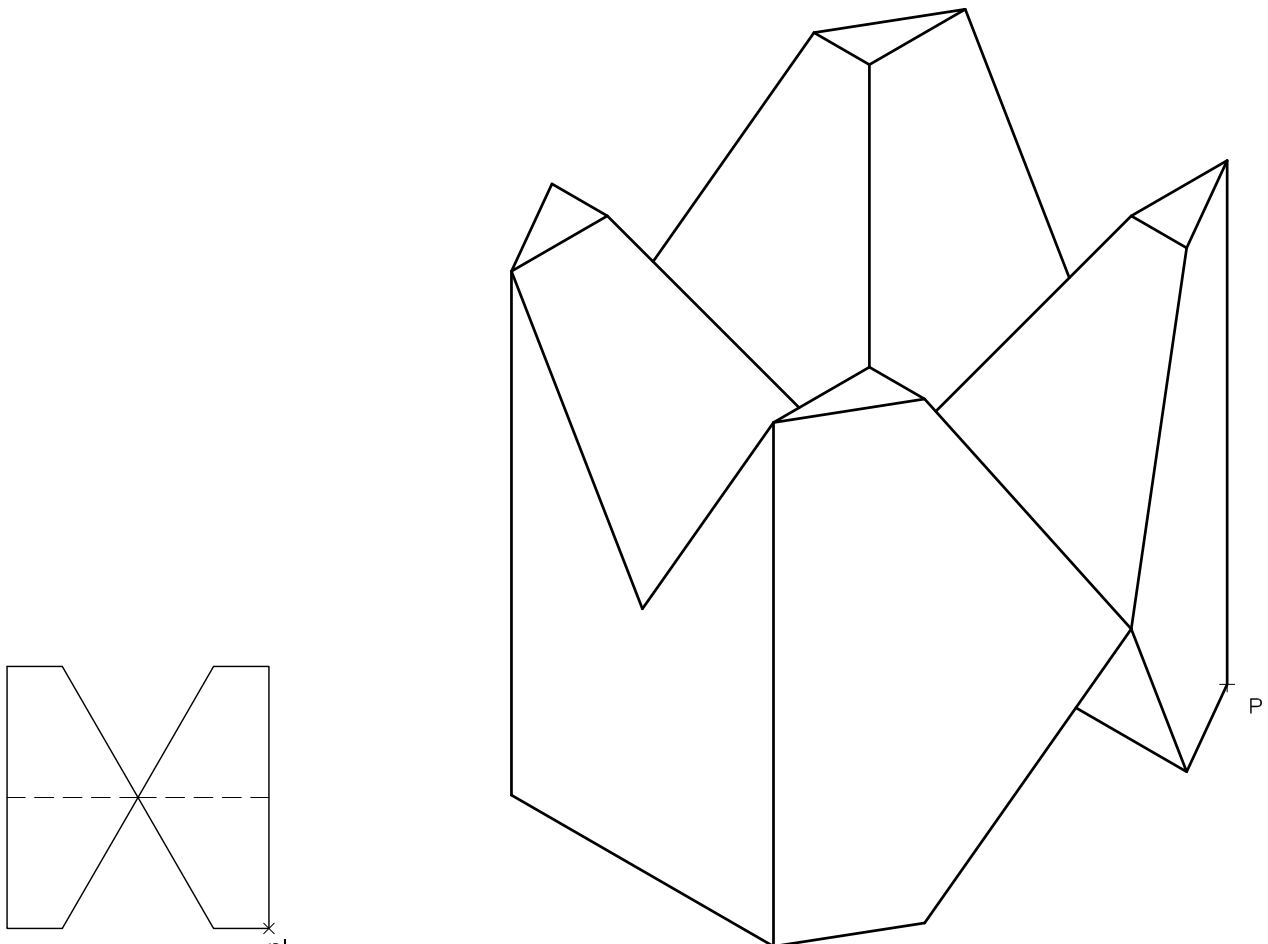
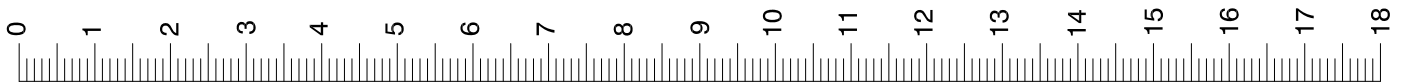

S3.3B

