

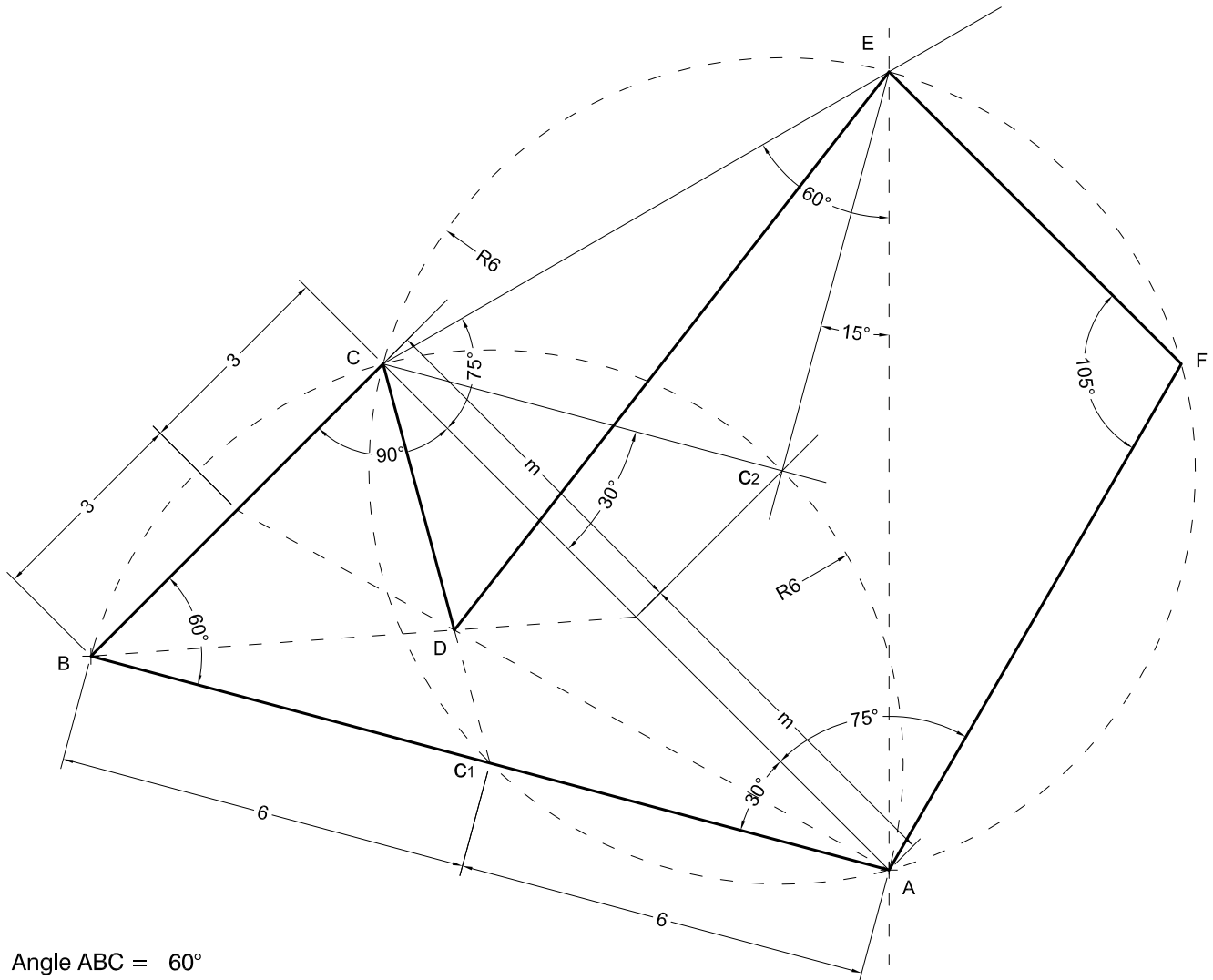

(1-1A)

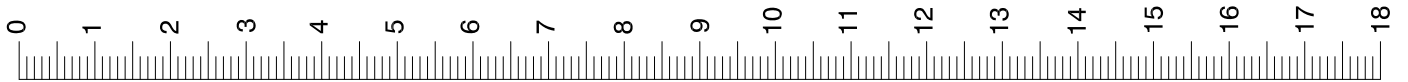

Angle ABC = 60°

Angle ACB = 90°

Vèrtex D = baricentre del triangle ABC

Angle ACE = 75°

Angle AEC = 60°

Angle CAF = 75°

Angle AFE = 105°



(1-1B)

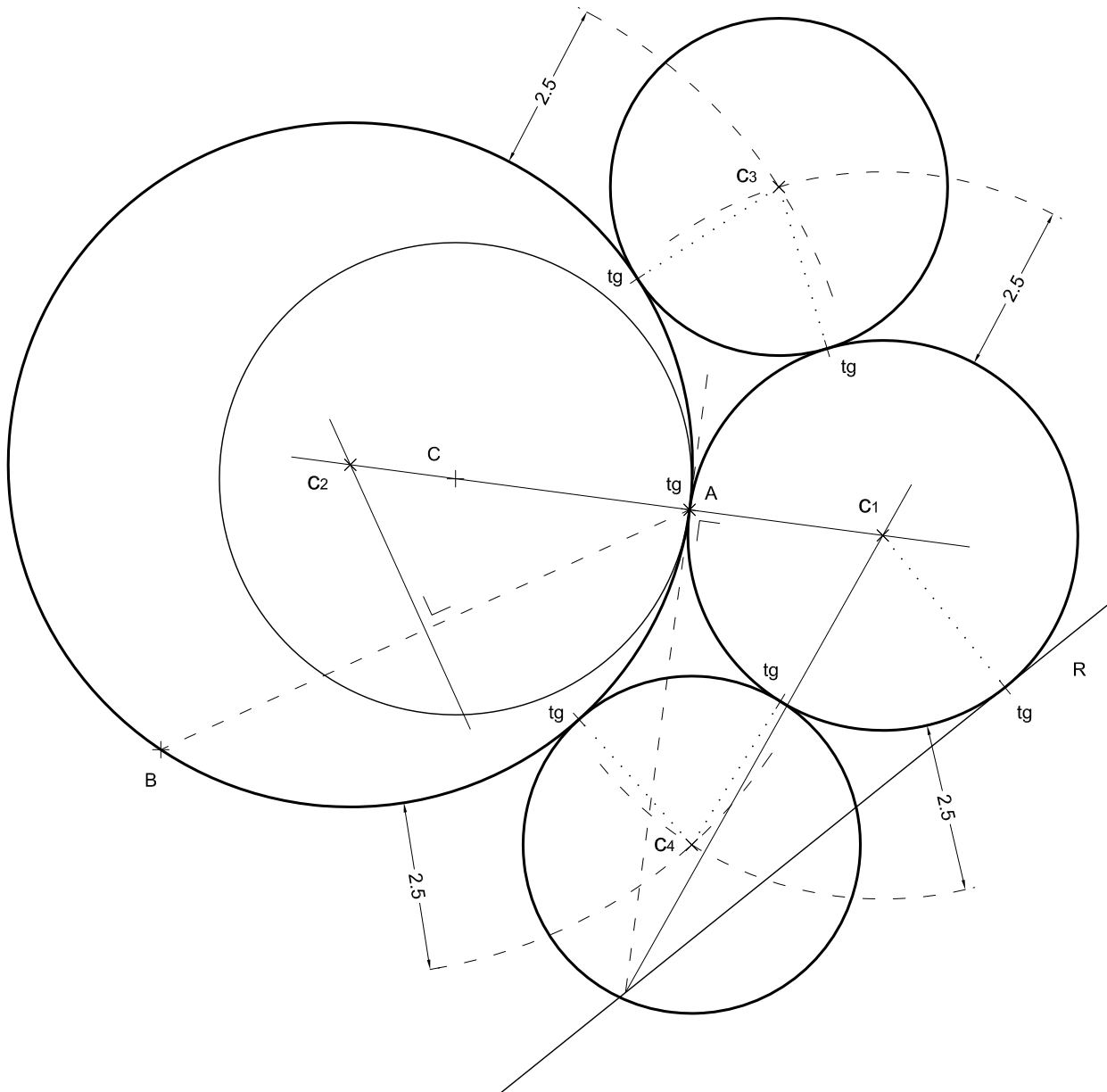
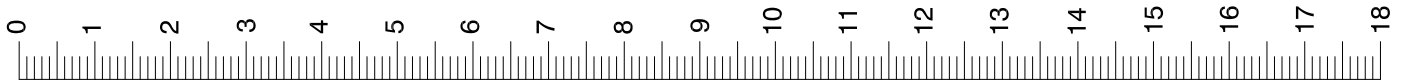



(1-2A)

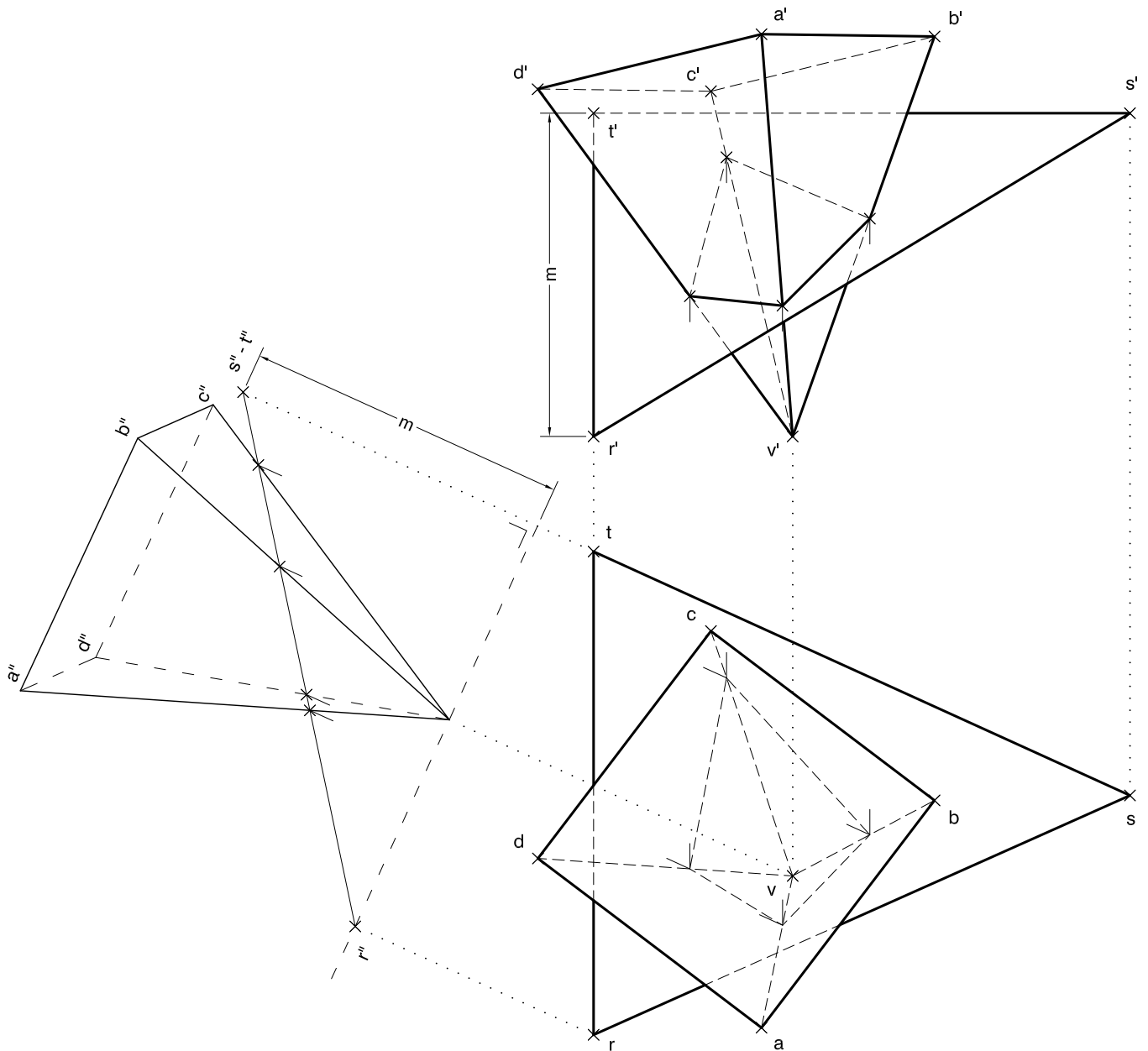
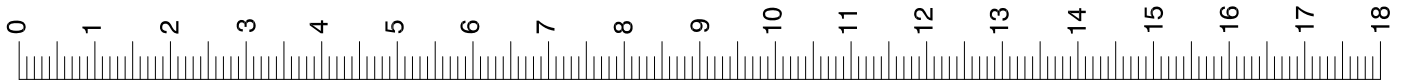



(1-2E)

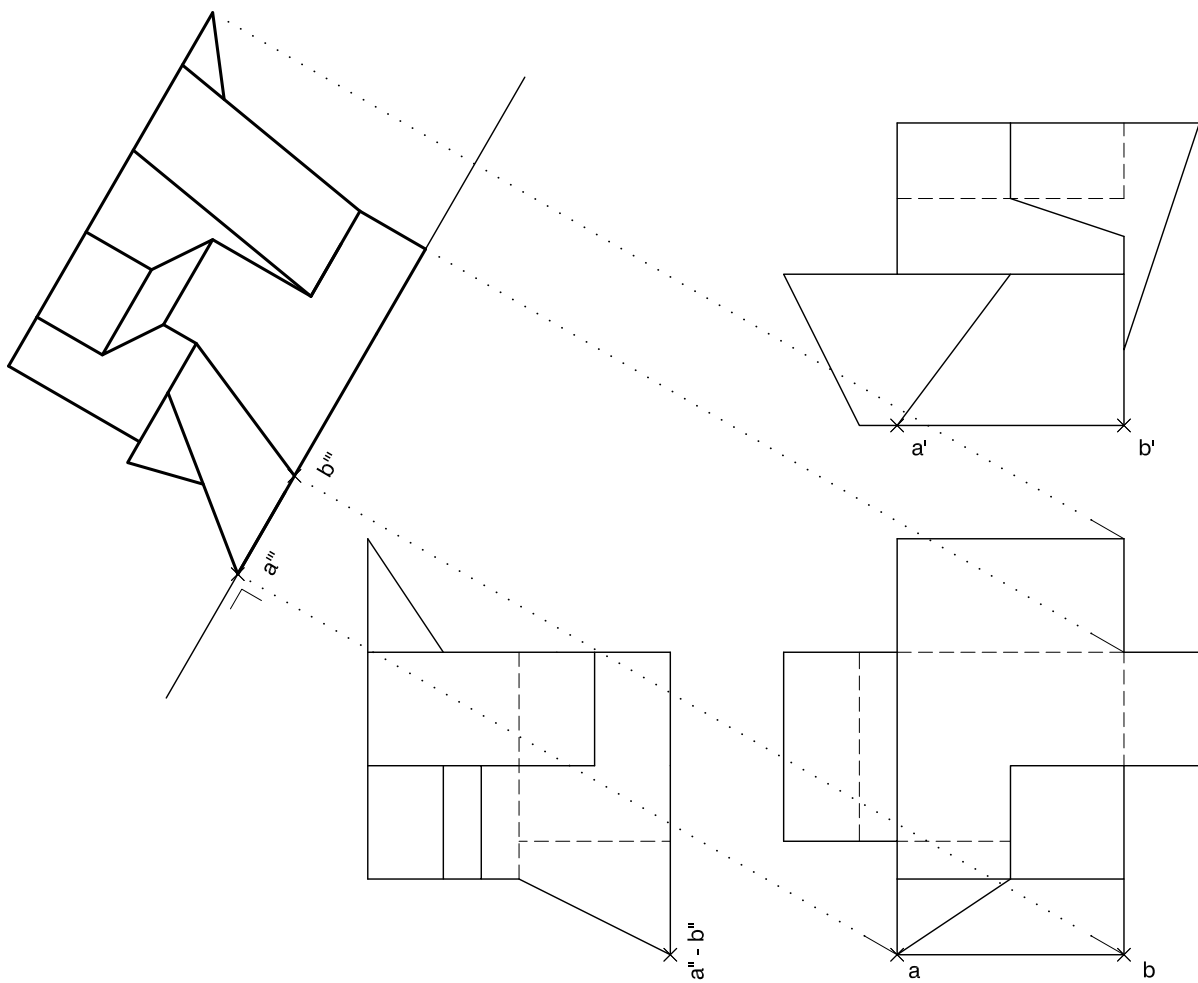



(13A)

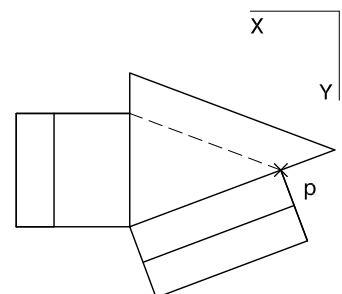
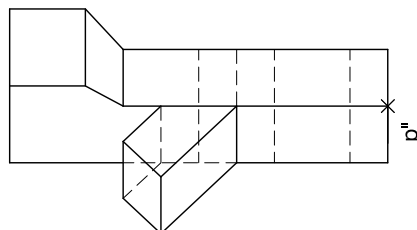
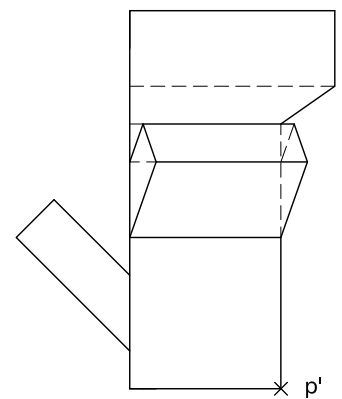
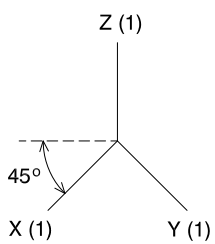
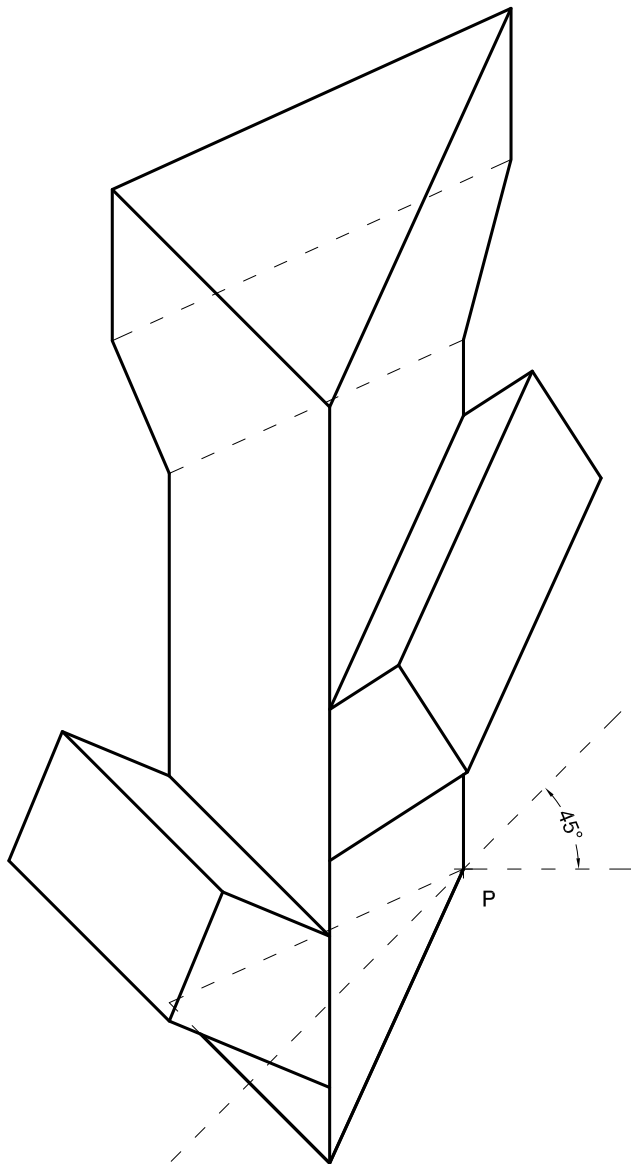
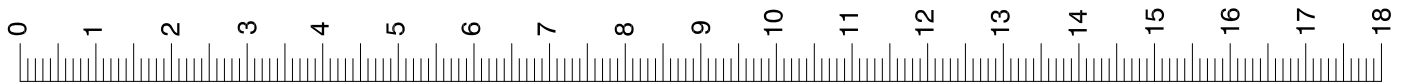



(1-3B)

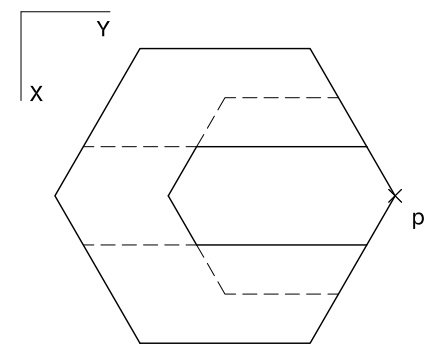
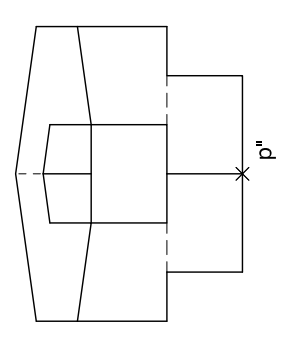
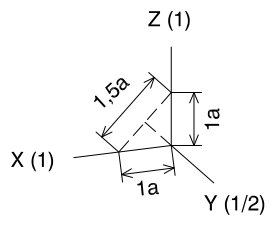
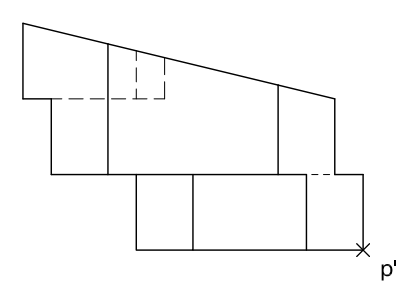
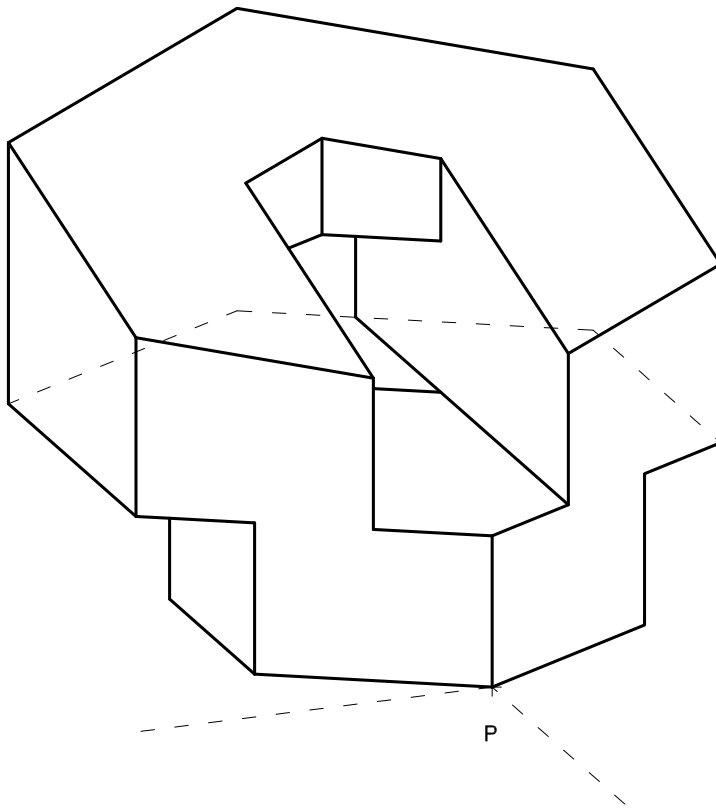
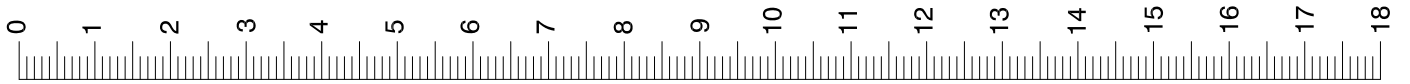



(3-1A)

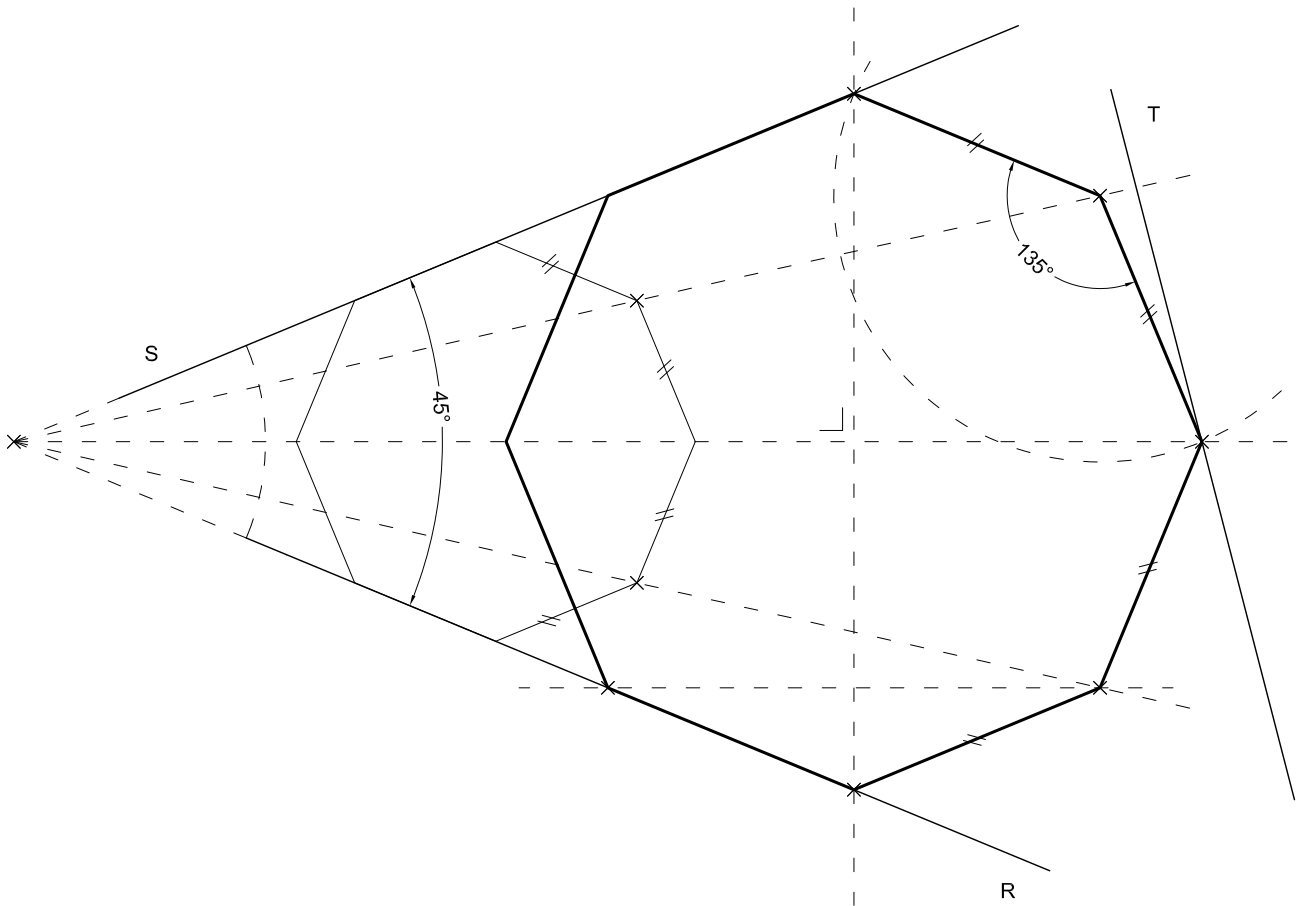
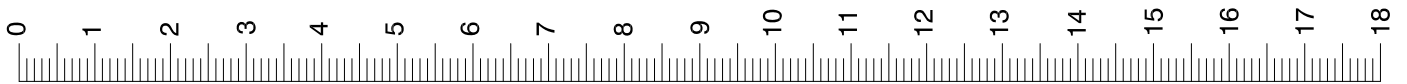

Segment R: 28,75 metres



(3-1B)

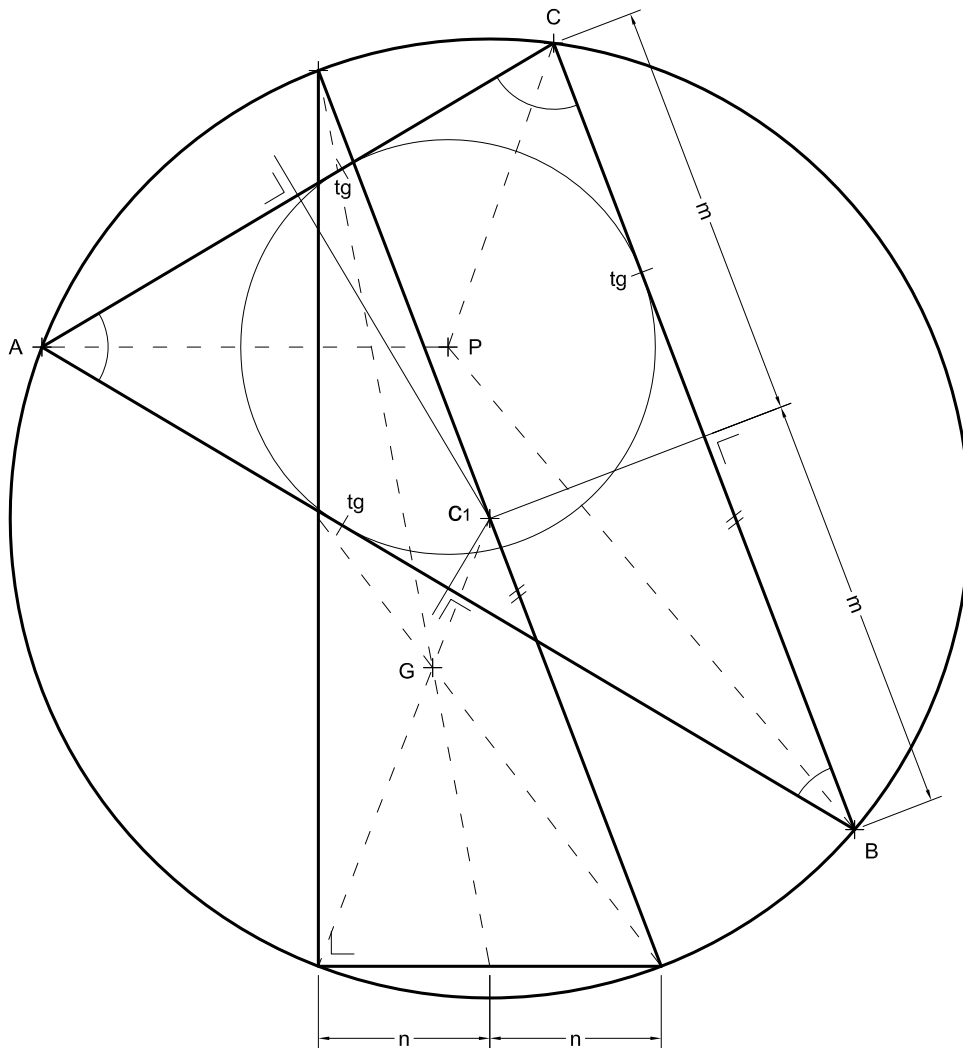
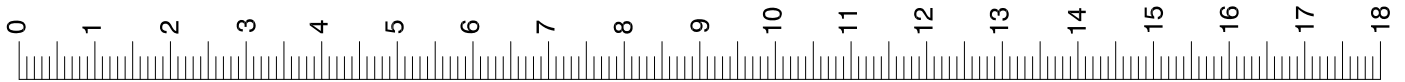



(3-2A)

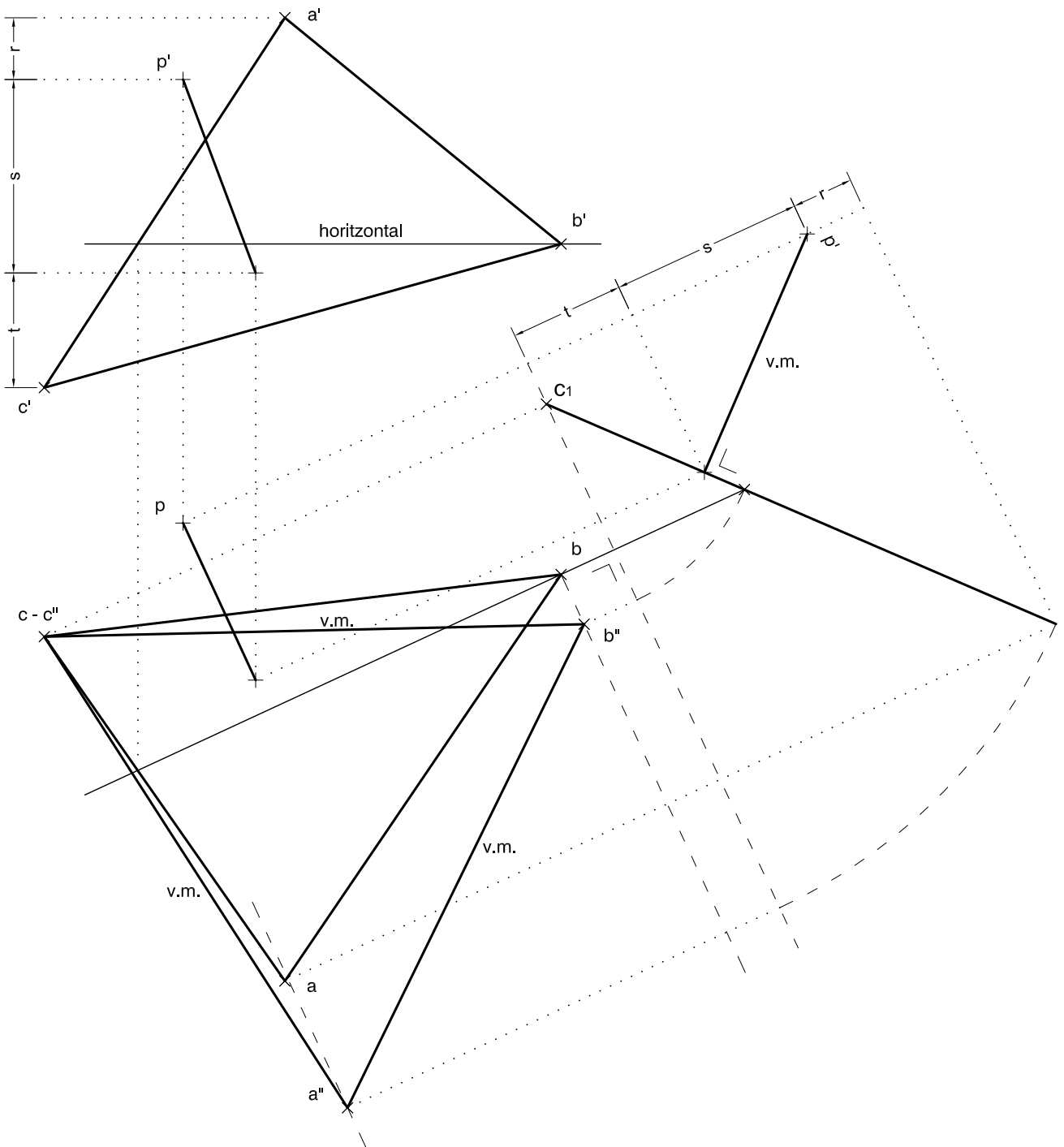
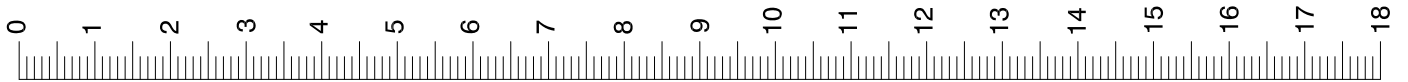



(3-2B)

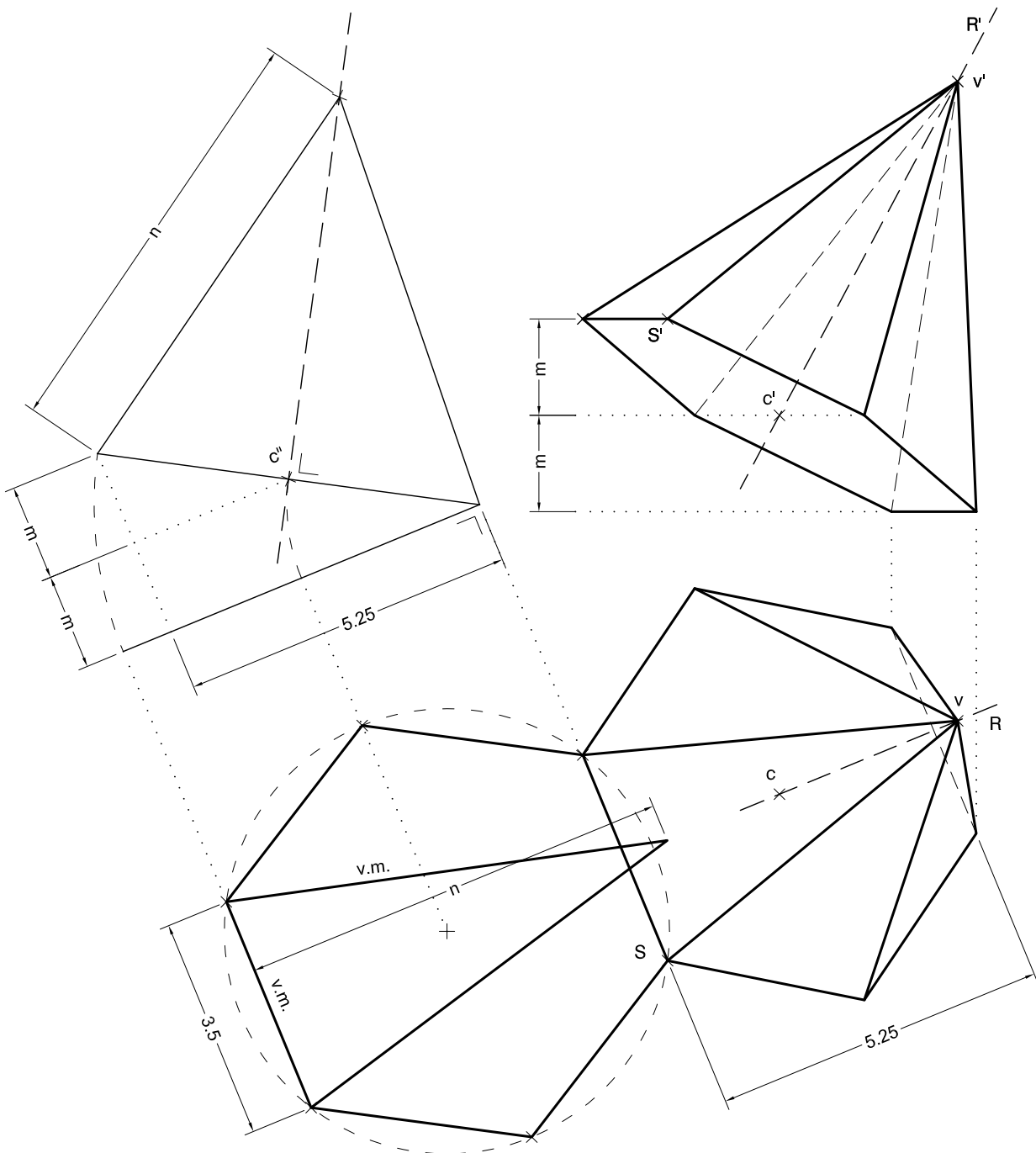
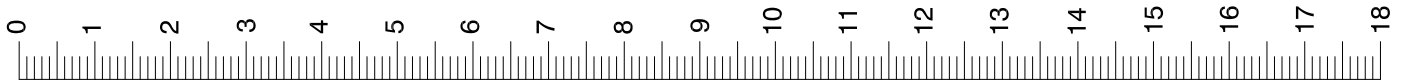



(3-2C)

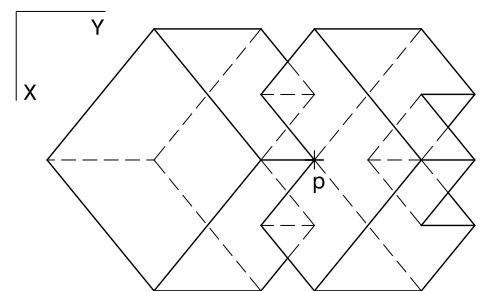
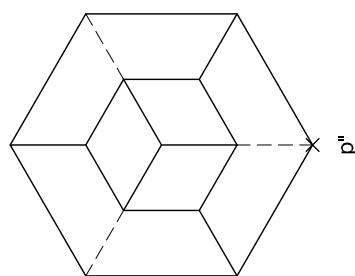
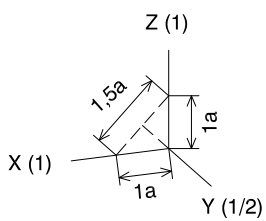
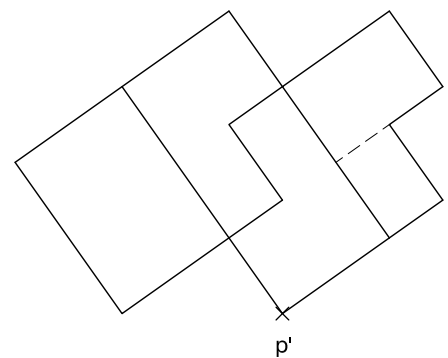
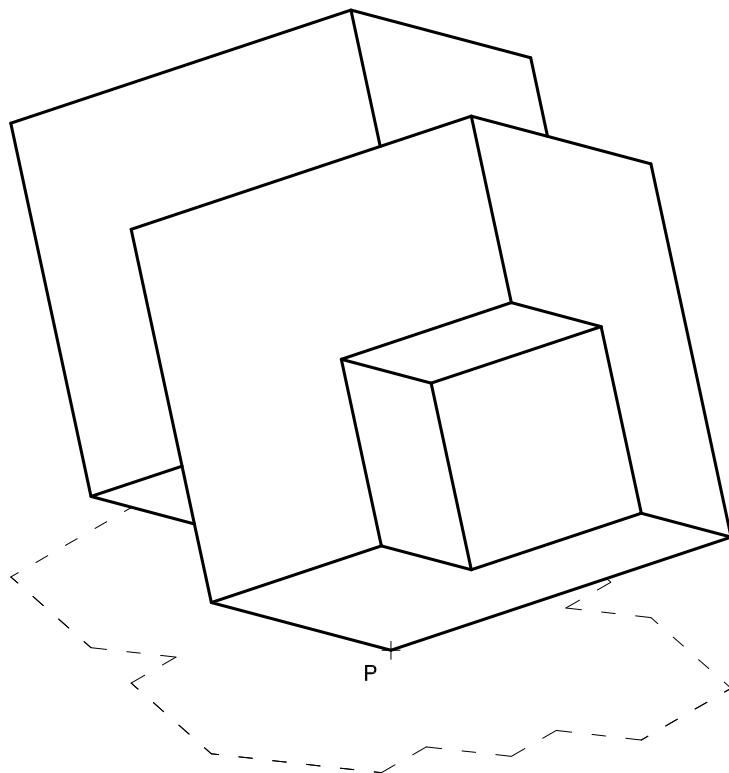



(3-2D)

